

REE
MODELES
La différence...



CATALOGUE

Édition 2021



REE
MODELES
La difference...



REE Modèles est heureux de vous présenter son catalogue de nouveautés!

Nous vous proposons cette année notre première machine à vapeur de l'Ouest, les remorques unifiées ainsi que les TGV-PSE, fleuron de l'industrie ferroviaire française, qui ont révolutionné le transport ferroviaire en Europe.

Autorails X-2800	p.4-5	Wagons trémies F70 Eads <i>série 1</i>	p.28-29
Remorques unifiées	p.6-7	Wagons trémies F70 Uas ballast <i>série 2</i>	p.30-31
TGV PSE	p.8-9	Wagons UFR bi-porteur <i>série 2</i>	p.32-33
030 Bourbonnais.....	p.10	Wagons UFR mono-porteur <i>série 5</i>	p.34-35
040-TA.....	p.11	Wagons plats OCEM 29 <i>série 4</i>	p.36-37
Coffret CAPITOLE.....	p.12-13	Wagons couverts OCEM 19 <i>série 3</i>	p.38-39
Voitures UIC couchettes <i>série 7</i>	p.15	Wagons couverts 20t PLM <i>série 3</i>	p.40-41
Voitures UIC <i>série 8</i>	p.16-17	Wagons citernes Fauvet-Girel <i>série 2</i>	p.42-43
Voitures Sud-Est métallisées <i>série 1</i>	p.18-19	Wagons plats TP <i>série 3</i>	p.44-45
Voitures Sud-Est métallisées <i>série 2</i>	p.20-21	Wagons tombereaux Tams <i>série 1</i>	p.46-47
Voitures DEV AO couchettes <i>série 1</i>	p.22-23	Wagons tombereaux FAS <i>série 2</i>	p.48-49
Voitures DEV AO U52-53 <i>série 5</i>	p.24-25	Cars R4190 <i>série 2</i>	p.50
Voitures OCEM RA <i>série 3</i>	p.26-27		



Autorails X-2800

Caractéristiques principales du modèle :

- modèles strictement à l'échelle HO 1/87^{ème} (longueur, largeur, hauteur respectées),
- près de 300 pièces par modèle : haut niveau de détails, intérieurs complets éclairés, nombreuses pièces en photodécoupe dont les grilles de ventilateurs en toiture,
- motorisation de haute qualité par moteurs à rotor sans fer, garantie d'un fonctionnement souple, silencieux et puissant,
- inscription en courbes minimum de 420 mm de rayon,
- interface digitale PluX 22, pour de nombreuses possibilités fonctionnelles,
- modèles DCC : décodeur Zimo de nouvelle génération, power-pack, sonorisation réaliste.

Ces modèles respectent nos standards très exigeants en termes de gravure, de décoration et de fidélité des variantes (dont certaines jamais reproduites en HO...). Le très célèbre son du moteur MGO sera reproduit comme il ne l'a jamais été !

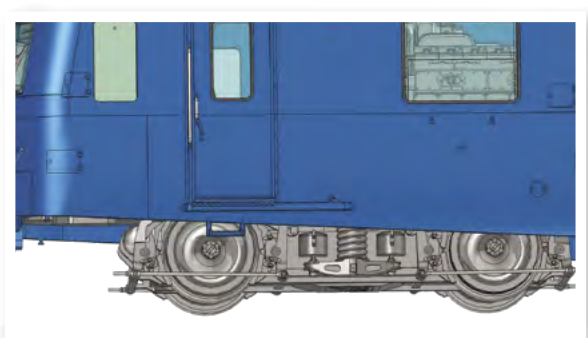
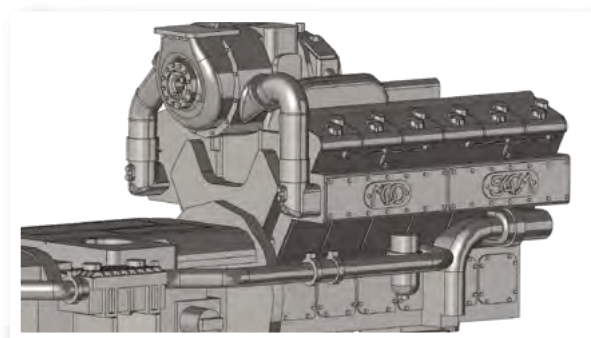
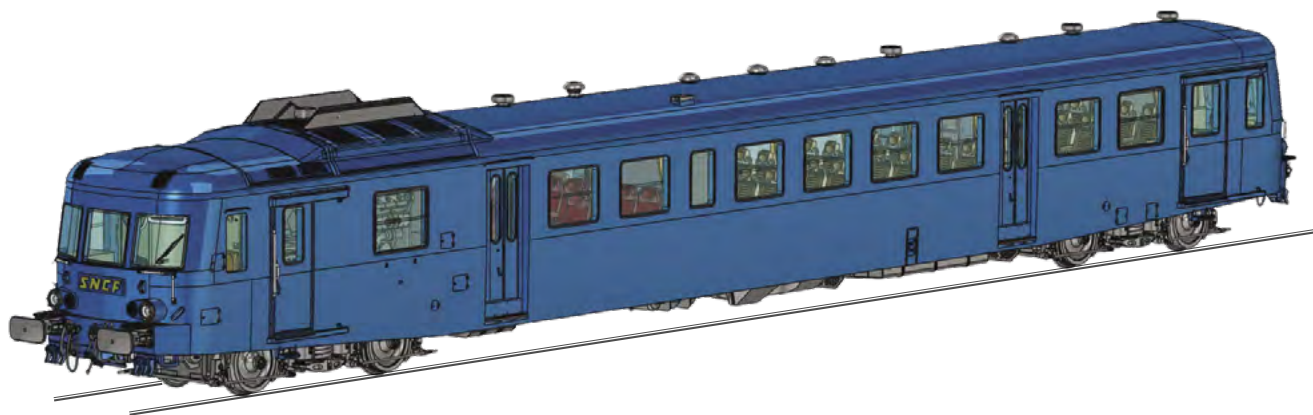

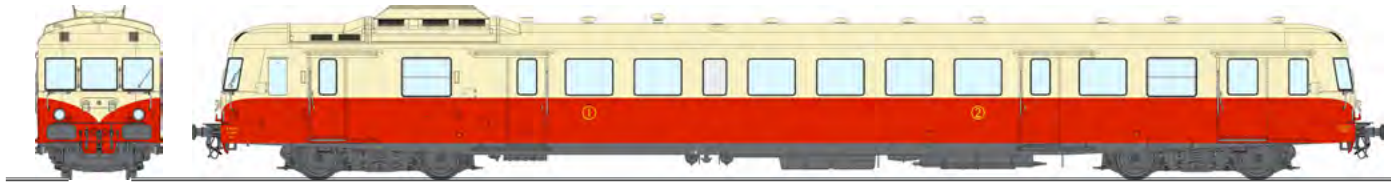
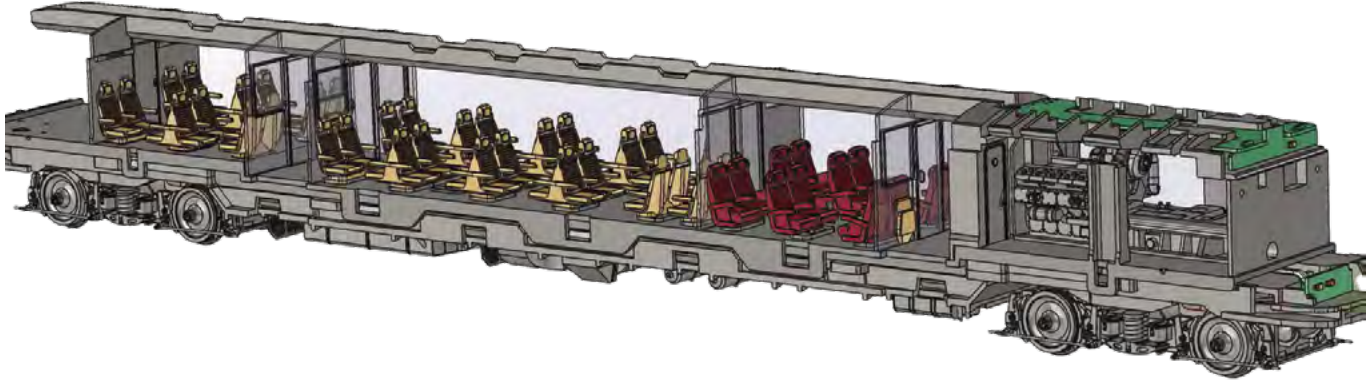

Autorail X-2828 version d'origine - Rouge 605 et Crème 407, LYON-VAISE, SNCF Ep. III

Réf. MB-161 - Modèle Analogique / Analog

Réf. MB-161 S - Modèle DCC sonorisé / DCC Sound

Réf. MB-161 SAC - Modèle AC digital Sonorisé - 3 Rails / AC SOUND / 3-Leiter AC Digital Sound

X-2828 Origin, Red 605 and Cream 407, Lyon-Vaise, SNCF Era III • X-2828, Ursprungsversion, Rot 605 und Creme 407, Lyon-Vaise, SNCF Ep. III

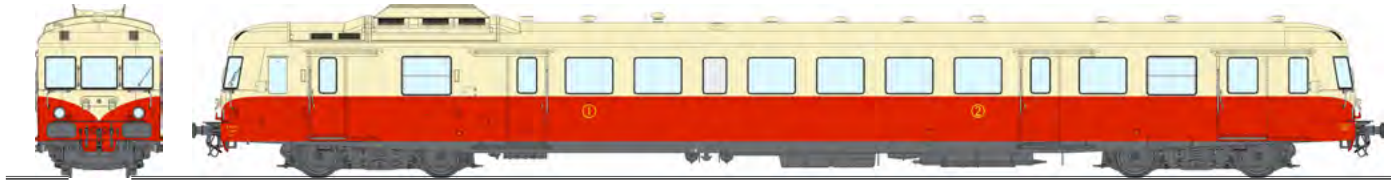

Autorail X-2825 version d'origine - Rouge 605 et Crème 407, TOULOUSE, SNCF Ep. III

Réf. MB-162 - Modèle Analogique / Analog

Réf. MB-162 S - Modèle DCC sonorisé / DCC Sound

Réf. MB-162 SAC - Modèle AC digital Sonorisé - 3 Rails / AC SOUND / 3-Leiter AC Digital Sound

X-2825 Origin, Red 605 and Cream 407, Toulouse, SNCF Era III • X-2825, Ursprungsversion, Rot 605 und Creme 407, Toulouse, SNCF Ep. III



Autorail X-2816 modernisé - Bleu 202, Blanc 708 et Gris 804, logo en relief, LYON-VAISE, SNCF Ep. IV-V. Engin sauvegardé par « L'autorail X2800 du Haut-Doubs »

Réf. MB-163 - Modèle Analogique / Analog

Réf. MB-163 S - Modèle DCC sonorisé / DCC Sound

Réf. MB-163 SAC - Modèle AC digital Sonorisé - 3 Rails / AC SOUND / 3-Leiter AC Digital Sound

X-2816 modernized, Blue 202, White 708 and Grey 804, relief logo, LYON-VAISE, SNCF Era IV-V. Railcar saved by « L'autorail X2800 du Haut-Doubs » • X-2816 modernisiert, Blau 202, Weiß 708 und Grau 804, Schriftzug erhaben, Lyon-Vaise, SNCF Ep. IV-V, Museumsfahrzeug « L'autorail X-2800 du Haut-Doubs »



Autorail X-2805 modernisé - Bleu 202, Blanc 708 et Gris 804, logo Nouille, LIMOGES, SNCF Ep.V-VI.

Réf. MB-164 - Modèle Analogique / Analog

Réf. MB-164 S - Modèle DCC sonorisé / DCC Sound

Réf. MB-164 SAC - Modèle AC digital Sonorisé - 3 Rails / AC SOUND / 3-Leiter AC Digital Sound

X-2805 modernized, Blue, spaghetti logo, LIMOGES, SNCF Era V-VI • X-2805 modernisiert, Blau 202, Weiß 708 und Grau 804, Nudel-Logo, Limoges, SNCF Ep. IV-V

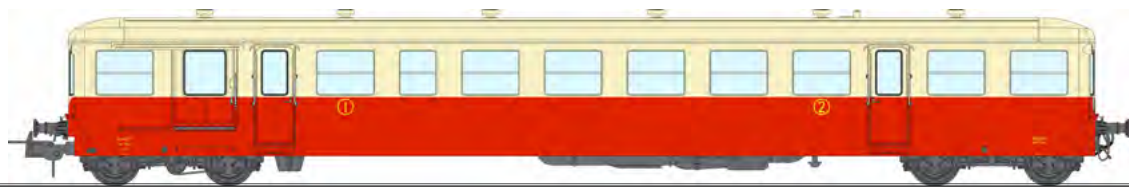
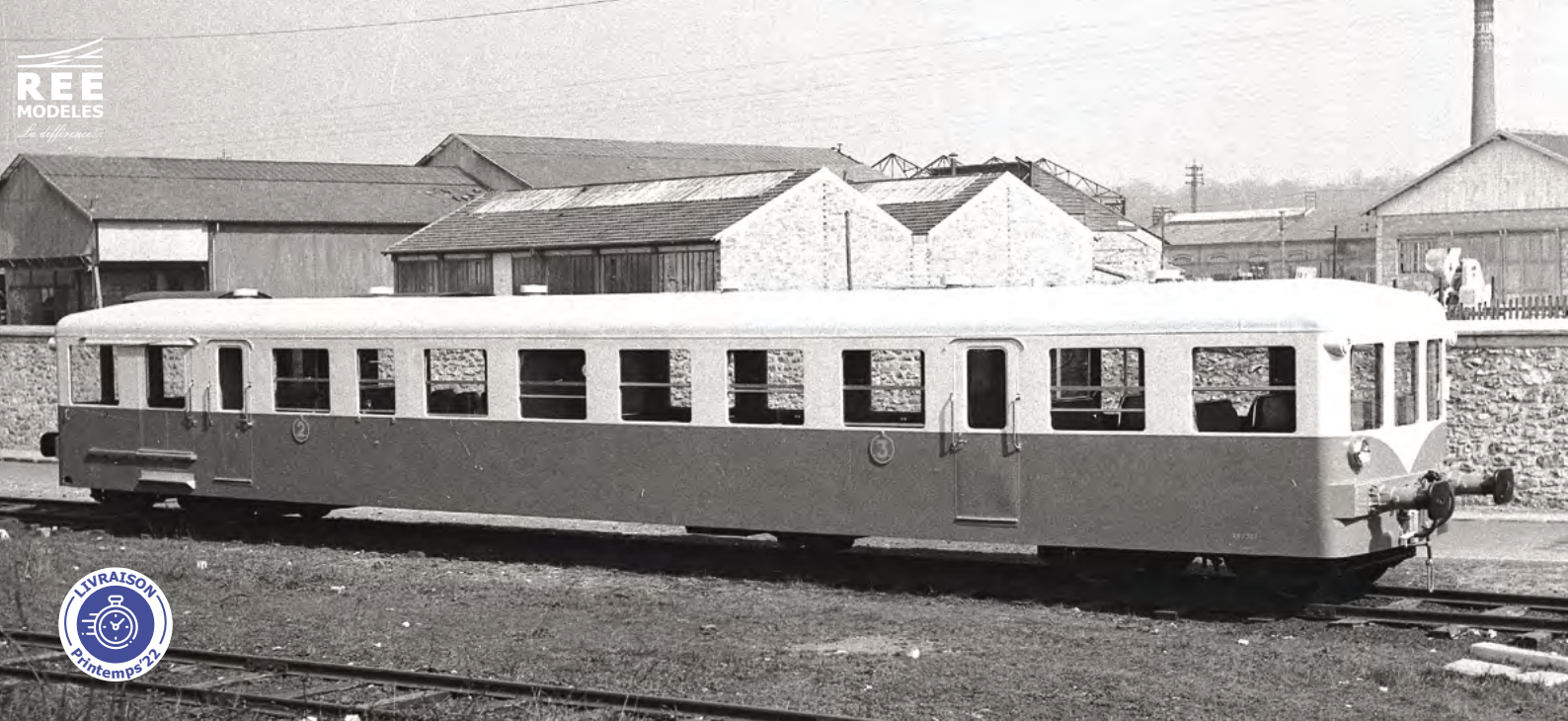

Remorque XR-7354 - Petit fourgon, fanoux, rouge et crème, toit crème - LYON-VAISE Ep.III

Réf. VB-441 - Analogique & DCC

Réf. VB-441 AC - AC système 3 rails digital

XR-7354 Small van, corner light Red-Cream with Cream Roof LYON-VAISE Era III

XR-7354 Kleiner Gepäckraum, rote Oberlichter, Rot / Crem, Dach Crem LYON-VAISE Ep.III

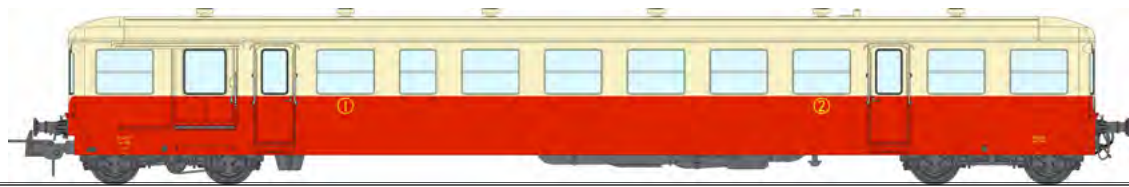

Remorque XR-7397 - Petit fourgon, fanoux, rouge et crème, toit crème - BORDEAUX Ep.III

Réf. VB-442 - Analogique & DCC

Réf. VB-442 AC - AC système 3 rails digital

XR-7397 Small van, corner light Red-Cream with Cream Roof BORDEAUX Era III

XR-7397 Kleiner Gepäckraum, rote Oberlichter, Rot / Crem, Dach Crem BORDEAUX Ep. III

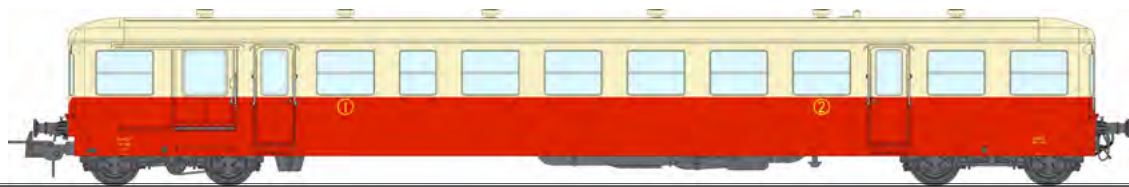

Remorque XR-7405 - Petit fourgon, fanoux, rouge et crème, toit crème - LIMOGES Ep.III

Réf. VB-443 - Analogique & DCC

Réf. VB-443 AC - AC système 3 rails digital

XR-7405 Small van, corner light Red-Cream with Cream Roof LIMOGES Era III

XR-7404 Kleiner Gepäckraum, rote Oberlichter, Rot / Crem, Dach Crem LIMOGES Ep. III

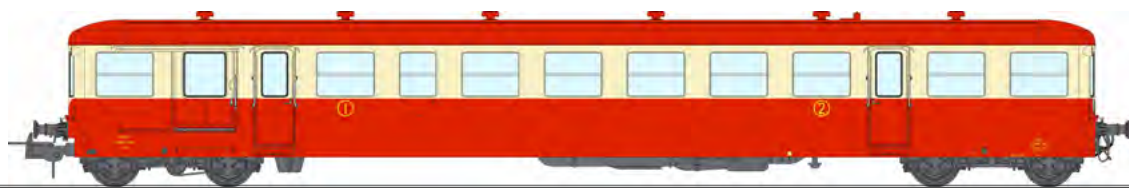

Remorque XR-7487 - Petit fourgon, fanoux, rouge et crème, toit rouge - LILLE Ep.IV

Réf. VB-444 - Analogique & DCC

Réf. VB-444 AC - AC système 3 rails digital

XR-7487 Large van, corner light Red-Cream with Red Roof LILLE Era IV

XR-7487 Kleiner Gepäckraum, rote Oberlichter, Rot / Crem, Dach Rot LILLE Ep. IV

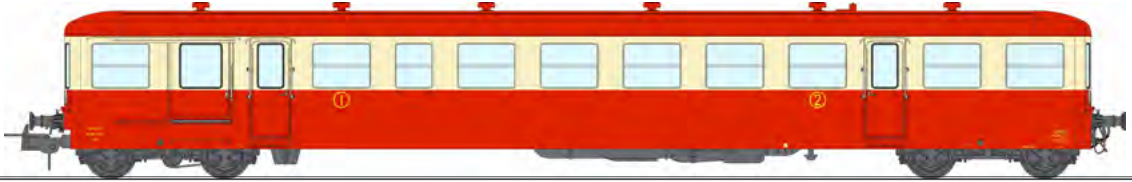
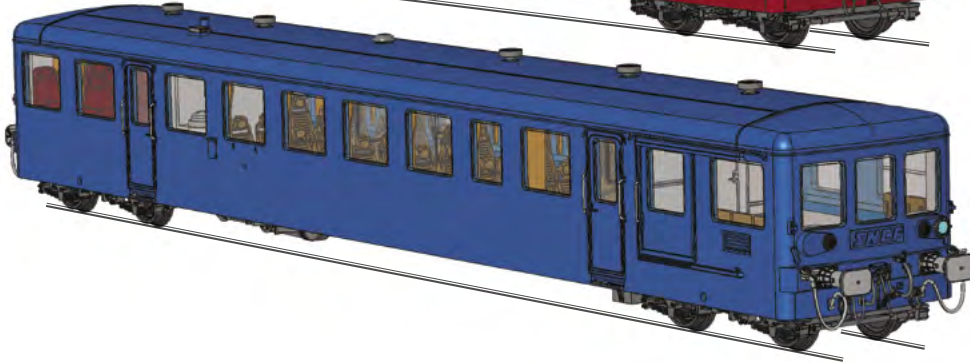

Remorque XR-7377 - Petit fourgon, rouge et crème, toit rouge - GRENOBLE Ep.IV

Réf. VB-445 - Analogique & DCC

Réf. VB-445 AC - AC système 3 rails digital

XR-7377 Small van, Red-Cream with Red Roof GRENOBLE Era IV

XR-7377 Kleiner Gepäckraum, Rot / Crem, Dach Rot GRENOBLE Ep. IV

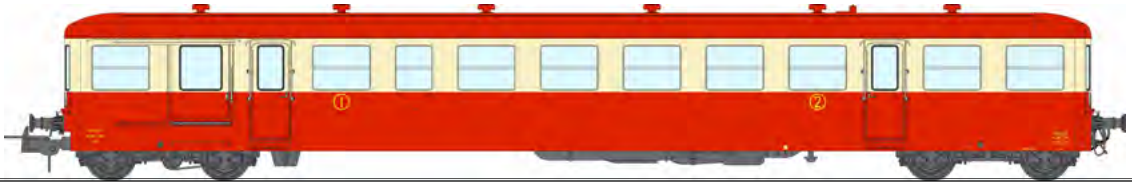

Remorque XR-7360 - Rouge et crème, toit rouge - SOTTEVILLE Ep.IV

Réf. VB-446 - Analogique & DCC

Réf. VB-446 AC - AC système 3 rails digital

XR-7360 Small van, Red-Cream with Red Roof SOTTEVILLE Era IV

XR-7360 Kleiner Gepäckraum, Rot / Crem, Dach Rot SOTTEVILLE Ep. IV



Remorque XR-8274 - Modernisée bleue - DIJON Ep.IV-V

Réf. VB-447 - Analogique & DCC

Réf. VB-447 AC - AC système 3 rails digital

XR-8274 Modernized Blue DIJON Era IV-V

XR-8274 Modernisiert Blau DIJON Ep. IV-V



Remorque XR-8285 - Modernisée bleue - DIJON Ep.IV-V

Réf. VB-448 - Analogique & DCC

Réf. VB-448 AC - AC système 3 rails digital

XR-8285 Modernized Blue DIJON Era IV-V

XR-8285 Modernisiert Blau DIJON Ep. IV-V

En préparation dans la gamme REE COLLECTION : la rame n°16 à 7 éléments, détentrice du record du monde le 26 février 1981, à la vitesse de 380 Km/h.



Rame avec suspensions à ressorts 1^{ère}/2^{ème} cl. - n° 69



Caractéristiques principales du modèle :

- rayon de courbure minimum : 360 mm
- moteur avec volants d'inertie dans chaque motrice
- bandages d'adhérence (essieux sans bandages disponibles dans la gamme accessoires REE)
- attelages à élévation entre tous les éléments de la rame
- phares blancs et feux rouges (avec inversion en fonction du sens de marche),
- 3^{ème} phare fonctionnel (commandé sur les versions DCC et AC Sound)
- éclairage cabine
- éclairage intérieur (commandé sur les versions DCC et AC Sound)
- pantographes fonctionnels motorisés (version DCC et AC Sound)
- aménagement intérieur réaliste et conforme
- chaque motrice est sonorisée en version digitale
- possibilité de coupler les rames en UM (rayon mini : 420 mm)

Le coffret de base permet de réaliser une rame à 5 éléments avec le bar ; c'est la composition minimale. Avec les deux coffrets complémentaires, il est possible de réaliser une rame de 7 éléments (base + 2 voitures) ou 8 éléments (base + 3 voitures). L'ensemble des 3 coffrets permet d'obtenir la rame complète réelle.

Main spécifications :

Minimum curve radius : 360 mm, each locomotive fits motor with flywheel, traction tyres (axles w/o tyres are available in REE accessories range), short coupling, white and red lights (according running direction), working top white 3rd light (remote control on DCC and AC Sound versions), driver's cab lighting, coach interiors lighting (remote control on DCC and AC Sound versions), working motorized pantographs (DCC and AC Sound versions), accurate and realistic interiors, true to the original.

The basic set makes it possible to form a 5 units train including the bar. This is the minimum configuration. The two additional sets are making possible to form either a 7 unit train (basic set + 2 coach) or a 8 units train (basic + 3 coaches). The whole 3 sets enables you to get a 10 units train true to the real TGV.

Technische daten :

Mindestradius: 360 mm, motor mit Schwungmasse in jeden Triebkopf, mit Haftreifen (Räder ohne Haftreifen sind als REE Zubehör erhältlich), kurzkupplung an allen Wagen, Lichtwechsel rot/weiß (entsprechend der Fahrtrichtung), 3. Licht (steuerbar in den DCC und AC Sound Ausführungen), Führerstandbeleuchtung, Innenbeleuchtung (steuerbar in den DCC und AC Sound Ausführungen), motorisierte Dachstromabnehmer (steuerbar in den DCC und AC Sound Ausführungen), vorbildgetreue realistische Inneneinrichtung.

Die Grundpackung erlaubt einen 5-teiligen Triebzug mit Bar zu erstellen. Es ist die kleinste Zusammenstellung. Anhand der zwei Erweiterungsset ist es möglich einen 7-teiligen Triebzug (Grundset + 2 Mittelwagen) oder 8-teiligen Triebzug (Grundset + 3 Mittelwagen) zusammenzustellen.

TGV

Longueur de la rame

5 éléments :	1.228 mm
7 éléments :	1.658 mm
8 éléments :	1.873 mm
10 éléments :	2.303 mm



**TGV PSE Rame Origine n°69
suspensions à ressorts
SNCF Ep. IV**

**Coffret 5 éléments : 2 motrices +
remorques R1 + R8 + R4 Bar**

*TGV PSE n°69 train original condition,
spring suspension, SNCF Ep.IV
5 units set : engine x2 + R1 + R8 +
R4 Bar coach.*

*TGV PSE Triebzug in Ursprungsaus-
führung Nr. 69 Stahlfederung SNCF
Ep. IV
5.-teiliges Zugset: Triebköpfe + End-
wagen R1 + R8 + Mittelwagen R4 Bar*

Réf. TGV-001
Analogique / DC Analog

Réf. TGV-001S
DCC sonorisé / DCC Sound

Réf. TGV-001SAC
AC digital sonorisé - 3 Rails
AC digital sound - 3 Rails system
3-Leiter AC Digital Sound



**Coffret 3 éléments :
remorques R2 + R5 + R6
TGV PSE Rame Origine suspen-
sions à ressorts - SNCF Ep. IV**

*TGV PSE n°69 train original condition,
spring suspension, SNCF Ep.IV
3 units set : R2 + R5 + R6 coaches*

*TGV PSE Triebzug in Ursprungsaus-
führung Stahlfederung SNCF Ep. IV
3.-teiliges Erweiterungsset: Mittelwa-
gen R2 + R5 + R6*

Réf. TGV-002
Analogique & DCC / DCC & Analog

Réf. TGV-002SAC
AC digital sonorisé - 3 Rails
AC digital sound - 3 Rails system
3-Leiter AC Digital Sound



**Coffret 2 éléments :
remorques R3 + R7 TGV PSE
Rame Origine suspensions à
ressorts - SNCF Ep. IV**

*TGV PSE n°69 train original condition,
spring suspension, SNCF Ep.IV
2 units set : R3 + R7 coaches*

*TGV PSE Triebzug in Ursprungsaus-
führung Stahlfederung SNCF Ep. IV
2.-teiliges Erweiterungsset: Mittelwa-
gen R3 + R7*

Réf. TGV-003
Analogique & DCC / DCC & Analog

Réf. TGV-003SAC
AC digital Sonorisé - 3 Rails / AC digi-
tal sound - 3 Rails system / 3-Leiter
AC Digital Sound





Les 030 dites « Bourbonnais » font partie des premières machines de ligne du PLM. Celles reproduites par REE Modèles appartiennent aux séries 030 PLM n° 1401 à 2457. Avant la première guerre mondiale, 215 d'entre-elles furent transformées en machines-tenders de manœuvres numérotées 7401 à 7615 puis 3 AM 1 à 215. Les dernières seront réformées à la SNCF en 1967.

Caractéristiques principales du modèle :

- Moteur à rotor sans fer
- Lanternes fonctionnelles blanc/rouge
- Éclairage du foyer
- Son et Fumée sur les modèles DCC et AC Sound
- Fumigène SEUTHE



030 n° 1976 Tender 2399 abri Hironde PLM Ep.II

Réf. MB-187 - Modèle Analogique / Analog

Réf. MB-187 S - Modèle DCC sonorisé et fumée / DCC Sound and Smoke

Réf. MB-187 SAC - Modèle AC digital Sonorisé - 3 Rails / AC Sound & Smoke / 3-Leiter AC Digital Sound

030 Bourbonnais n° 1976 Tender 2399 swallow shelter PLM Era II • 030 Nr. 1976 Tender 2399 Schwalbe Wetterschutz PLM Ep. II

030 n° 1576 Tender B-51 avec cabine PLM Ep.II

Réf. MB-188 - Modèle Analogique / Analog

Réf. MB-188 S - Modèle DCC sonorisé et fumée / DCC Sound and Smoke

Réf. MB-188 SAC - Modèle AC digital Sonorisé - 3 Rails / AC Sound & Smoke / 3-Leiter AC Digital Sound

030 Bourbonnais n° 1576 Tender B-51 with open Cabin PLM Era II • 030 Nr. 1576 Tender B-51 mit Führerhaus PLM Ep. II

030 n° 3 A 26 Tender B-480 avec cabine PLM Ep.II (numérotation 1925)

Réf. MB-189 - Modèle Analogique / Analog

Réf. MB-189 S - Modèle DCC sonorisé et fumée / DCC Sound and Smoke

Réf. MB-189 SAC - Modèle AC digital Sonorisé - 3 Rails / AC Sound & Smoke / 3-Leiter AC Digital Sound

030 Bourbonnais n° 3 A 26 Tender B-480 with open Cabin PLM Era II (1925 Number) • 030 N° 3 A 26 Tender B-480 mit Führerhaus PLM Ep.II (Nummerierung 1925)

030 Bourbonnais n° 3 A 1 avec cabine SNCF Ep.III

Réf. MB-190 - Modèle Analogique / Analog

Réf. MB-190 S - Modèle DCC sonorisé et fumée / DCC Sound and Smoke

Réf. MB-190 SAC - Modèle AC digital Sonorisé - 3 Rails / AC Sound & Smoke / 3-Leiter AC Digital Sound

030 Bourbonnais n° 3 A 1 with open Cabin SNCF Era III • 030 Bourbonnais Nr. 3 A 1 mit Führerhaus SNCF Ep. III



REE met le cap à l'Ouest avec cette locomotive 040. Les modèles DCC Sound sont équipés d'un fumigène Seuthe, d'un éclairage de la cabine et du feu dans le foyer. Caractéristiques principales du modèle : moteur à rotor sans fer, lanternes fonctionnelles blanc/rouge, éclairage de la cabine, éclairage du foyer, son et fumée sur les modèles DCC et AC Sound.

DCC Sound models are equipped with a smoke unit, cabin light and red fire light.

Die REE zieht mit diesem D-Kuppler Richtung Westen. Die DCC-Sound-Modelle sind mit einem Seuthe Rauchgenerator, Führerstandsbeleuchtung und rotem Licht aus dem Feuerloch ausgestattet.

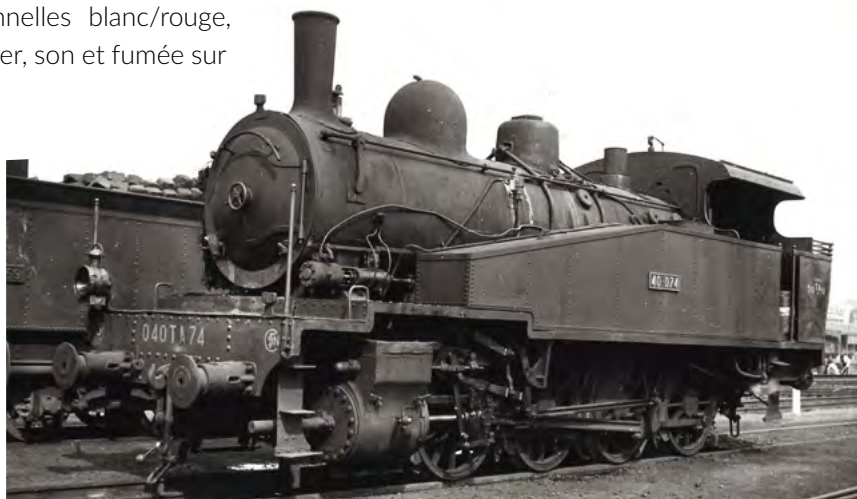

40-100 ETAT Cabine ouverte noire / gris anthracite TRAPPES hotte origine

Réf. MB-183 - Modèle Analogique / Analog

Réf. MB-183 S - Modèle DCC sonorisé et fumée / DCC Sound and Smoke

Réf. MB-183 SAC - Modèle AC digital Sonorisé - 3 Rails / AC Sound & Smoke / 3-Leiter AC Digital Sound

40-100 ETAT Open Cabin Black/Charcoal grey TRAPPES Original coal hood • 40-100 ETAT Offenes Führerhaus Schwarz / Anthrazit grau TRAPPES Ursprungskohlekasten

040 TA 74 / 40-074 SNCF Cabine ouverte noire/gris anthracite BATIGNOLLES hotte origine

Réf. MB-184 - Modèle Analogique / Analog

Réf. MB-184 S - Modèle DCC sonorisé et fumée / DCC Sound and Smoke

Réf. MB-184 SAC - Modèle AC digital Sonorisé - 3 Rails / AC Sound & Smoke / 3-Leiter AC Digital Sound

040 TA 74 / 40-074 SNCF Open Cabin Black/Charcoal grey BATIGNOLLES Original coal hood • 040 TA 74 / 40-074 SNCF Offenes Führerhaus Schwarz / Anthrazit grau BATIGNOLLES Ursprungskohlekasten

040 TA 55 SNCF Cabine ouverte verte et noire AURAY hotte origine

Réf. MB-185 - Modèle Analogique / Analog

Réf. MB-185 S - Modèle DCC sonorisé et fumée / DCC Sound and Smoke

Réf. MB-185 SAC - Modèle AC digital Sonorisé - 3 Rails / AC Sound & Smoke / 3-Leiter AC Digital Sound

040 TA 55 SNCF Open Cabin Green and Black AURAY Original coal hood • 040 TA 55 SNCF Offenes Führerhaus Grün und Schwarz AURAY Ursprungskohlekasten

040 TA 53 SNCF Cabine ouverte verte et noire SOTTEVILLE, TIA et réhausse de hotte

Réf. MB-186 - Modèle Analogique / Analog

Réf. MB-186 S - Modèle DCC sonorisé et fumée / DCC Sound and Smoke

Réf. MB-186 SAC - Modèle AC digital Sonorisé - 3 Rails / AC Sound & Smoke / 3-Leiter AC Digital Sound

040 TA 53 SNCF Open Cabin Green and Black SOTTEVILLE, with TIA • 040 TA 53 SNCF Offenes Führerhaus Grün und Schwarz SOTTEVILLE, TIA und überhöhter Kohlenkasten



Coffret CAPITOLE
"Le Capitole" Train Set - Zugset "Le Capitole"



Série numérotée 250 pièces avec numéros des matériels nouveaux et exclusifs à ce coffret REE COLLECTION. Première rame en circulation en Mai 1967.

Numbered series 250 pieces with new and exclusive equipment numbers. Auf 250 Stück limitierte Serie mit exklusiven Ordnungsnummern Erste Inbetriebnahme Mai 1967.

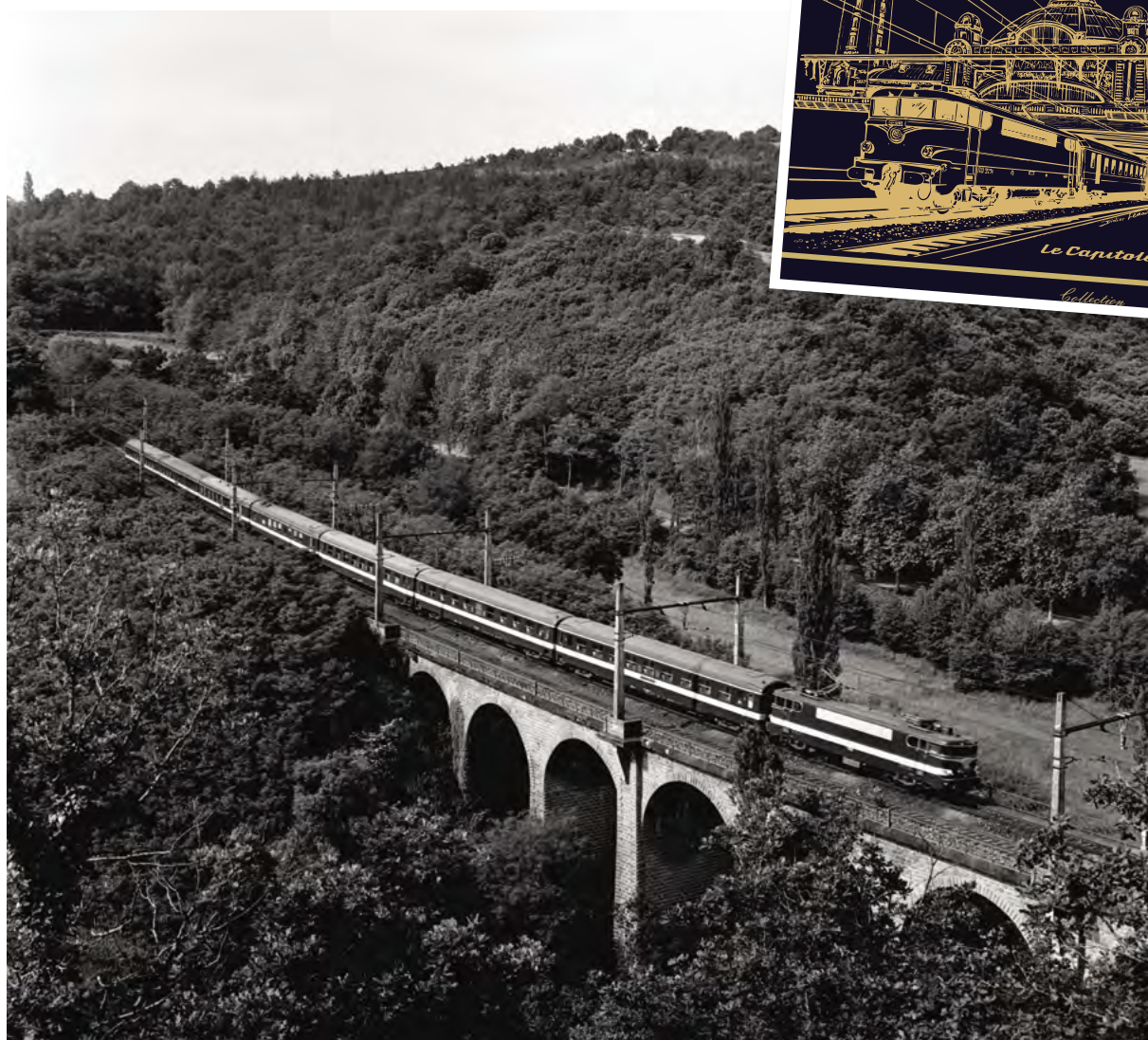



CM-016

Coffret « Le Capitole »

BB 9281 + 5 A9 + 1 A7D + 1 VRU

Locomotive analogique

Rame éclairée avec décodeur sur chaque voiture - Attelages à aimant

*Analog « Le Capitole » train set
BB 9281 + 5 A9 + 1 A7D + 1 VRU
(New Number)*

Cars with lights and magnet coupler.

Zugset "Le Capitole"

*BB 9281 + 5 A9 + 1 A7D + 1 VRU
Analog Lokomotive - Wageninnenbe-
leuchtung - Magnetkupplung.*



CM-016 S

Coffret « Le Capitole »

BB 9281 + 5 A9 + 1 A7D + 1 VRU

Locomotive DCC Sound

Pantographes fonctionnels

Rame éclairée avec décodeur sur chaque voiture - Attelages à aimant

*DCC Sound CAPITOLE train set
BB 9281 + 5 A9 + 1 A7D + 1 VRU
(New Number)*

*Cars with lights and magnet couplers,
decoder.*

Zugset "Le Capitole"

*BB 9281 + 5 A9 + 1 A7D + 1 VRU
Lokomotive DCC Sound - Stromab-
nehmer digital schaltbar - Wage-
ninnenbeleuchtung mit Decoder
- Magnetkupplung.*

CM-016 SAC

Coffret « Le Capitole »

BB 9281 + 5 A9 + 1 A7D + 1 VRU

Locomotive AC Sound

Pantographes fonctionnels

Rame éclairée avec décodeur sur chaque voiture - Attelages à aimant

*AC Sound CAPITOLE train set
BB 9281 + 5 A9 + 1 A7D + 1 VRU
(New Number) Cars with lights and
magnet couplers, decoder.*

Zugset "Le Capitole"

*BB 9281 + 5 A9 + 1 A7D + 1 VRU
Lokomotive 3-Leiter AC Sound -
Stromabnehmer digital schaltbar -
Wageninnenbeleuchtung mit Decoder
- Magnetkupplung.*

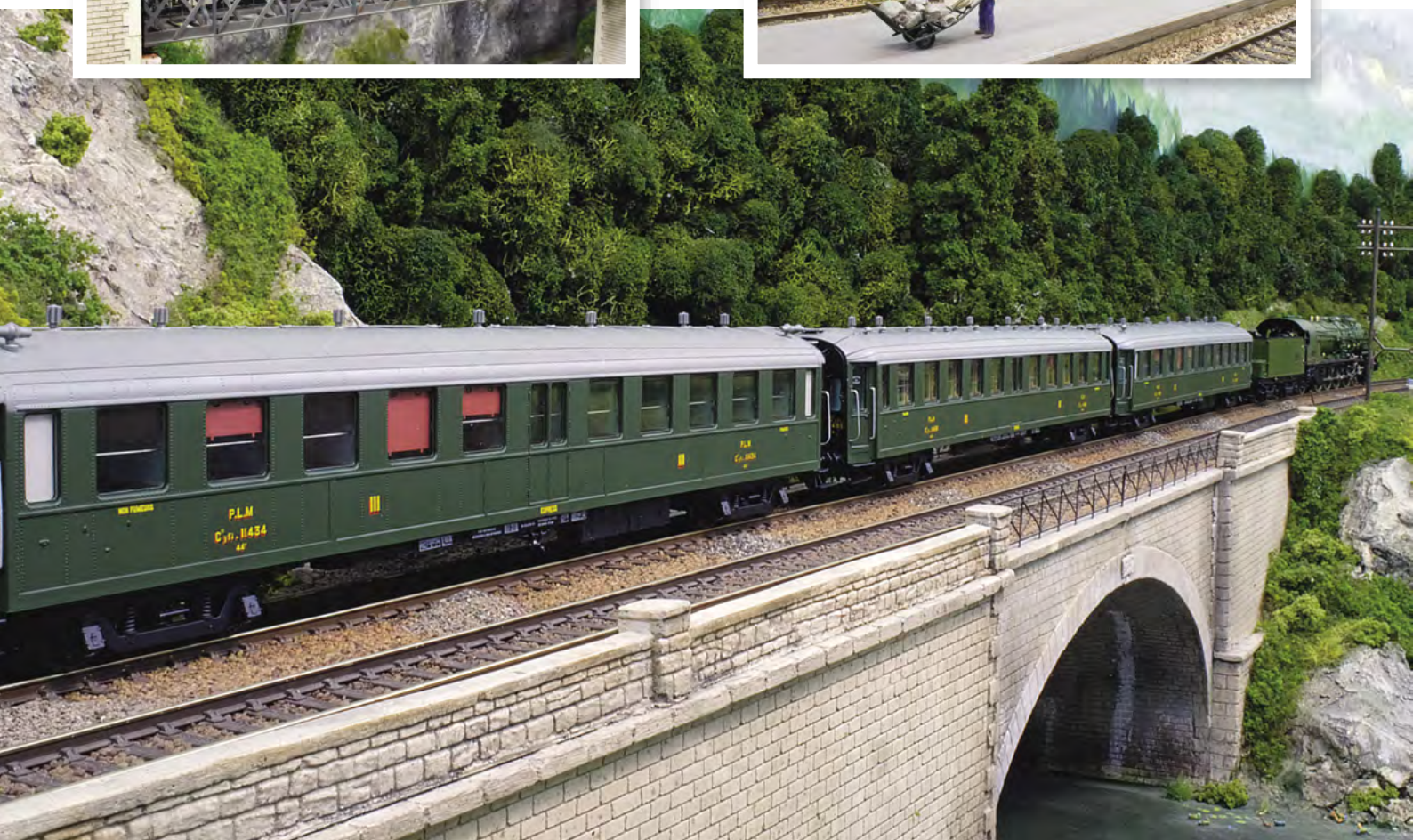



VB-296

Coffret 3 voitures UIC Couchettes

B9c9x toit haut

n° 51 87 59-70 920-8,

n° 51 87 59-70 945-5 et

n° 51 87 59-70 931-5, bleu 207/
gris 806, logo Nouille, SNCF Ep.V

*Set of 3 Sleeping UIC CARS B9c9x
Blue - Grey Silver 806
Spagetti Logo, high roof Era V*

*3er Set UIC Liegewagen B9c9x
erhöhtes Dach Nr. 51 87 59-70
920-8, 51 87 59-70 945-5 und
51 87 59-70 931-5,
blau 207/ grau 806, logo Nudel,
SNCF Ep. V*

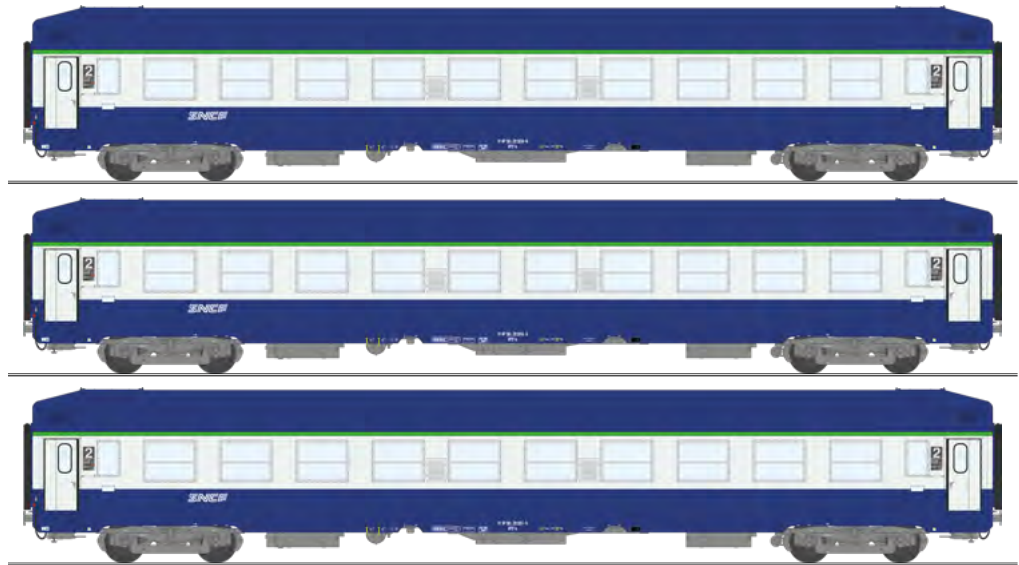

VB-297

Couchettes B9c9x toit haut

n° 51 87 59-70 948-9, bleu 207/
gris 806, logo Nouille, SNCF Ep.V

*B9c9x Blue - Grey Silver 806
Spagetti Logo, high roof Era V
B9c9x erhöhtes Dach - blau 207/
grau 806, logo Nudel, SNCF Ep. V*



VB-298

Coffret 3 voitures UIC Couchettes

B9c9x toit haut FTS

n° 51 87 59-70 822-6,

n° 51 87 59-70 823-4 et

n° 51 87 59-70 827-5,
vert 302 / gris métallisé / orange,
logo encadré jaune SNCF Ep.IV

*Set of 3 Sleeping UIC CARS B9c9x
Orange and green,
TRAIN SPECIAL FTS Era V*

*3er Set UIC Liegewagen B9c9x
erhöhtes Dach FTS
Nr. 51 87 59-70 822-6,
51 87 59-70 823-4 und
51 87 59-70 827-5, grün 302/
grau metallic / orange, logo gelb
umrahmt, SNCF Ep. IV*



VB-299

B9c9x toit haut FTS

n° 51 87 59-70 829-1, vert 302/ gris
métallisé/ orange, logo encadré jaune,
SNCF Ep.IV

*B9c9x Orange and green,
FTS Special Train Era V
B9c9x erhöhtes Dach FTS,
logo gelb umrahmt, SNCF Ep. IV*



Voitures UIC Couchettes
UIC couchette car · UIC Liegewagen



VB-300

B5Dd2, n° 51 87 82-70 008-3,
vert 302 / gris métallisé
SNCF Ep.IV

B5D Green / Alu Era IV

*B5Dd2, Nr. 51 87 82-70 008-3,
grün 302/grau metallic, SNCF Ep. IV*



VB-301

B5Dd2, n° 51 87 82-70 002-6,
vert 302 / gris métallisé toit gris,
logo encadré jaune, SNCF Ep.IV

B5Dd2 Green / Alu Grey roof Era IV

*B5Dd2, Nr. 51 87 82-70 002-6, grün
302/grau metallic Dach grau, Logo
gelb umrahmt, SNCF Ep.IV*



VB-302

B10, n° 51 87 20-80 642-2,
vert 302 / gris métallisé toit gris,
logo encadré jaune, SNCF Ep.IV

B10 Green / Alu Grey roof Era IV

*B10, Nr. 51 87 20-80 642-2, grün
302/grau metallic Dach grau, Logo gelb
umrahmt, SNCF Ep. IV*



VB-303

B5Dd2, n° 51 87 82-70 092-7,
vert 302 / gris 804 logo Nouille,
SNCF Ep.V

B5D Green / Grey Spagetti Logo Era V

*B5Dd2, Nr. 51 87 82-70 092-7, grün
302/ grau 804, Logo Nudel, SNCF Ep. V*



VB-304

B10, n° 51 87 20-71 751-2,
vert 302 / gris 804 logo Nouille,
SNCF Ep.V

B10 Green / Grey Spagetti Logo Era V

*B10, Nr. 51 87 20-71 751-2, grün 302/
grau 804, Logo Nudel, SNCF Ep. V*

VB-305

A9, n° 51 87 19-70 480-0
vert 302 / gris 804 logo Carmillon,
SNCF Ep.V

A9 Green / Grey «Carmillon» Logo Era V

*A9, Nr. 51 87 19-70 480-0, grün 302/
grau 804, Logo Carmillon, SNCF Ep. V*



VB-306

A9, n° 51 87 19-70 484-4
vert 302 / gris 804
logo Casquette, SNCF Ep.V

A9 Green / Grey Arrow Logo Era V

*A9, Nr. 51 87 19-70 484-4, grün 302/
grau 804, Logo Kappe, SNCF Ep. V*



VB-307

A9, n° 51 87 19-70 490-1
vert 302 / gris 804 logo Nouille,
SNCF Ep.V

A9 Green / Grey Spagetti Logo, Era V

*A9, Nr. 51 87 19-70 484-4, grün 302/
grau 804, Logo Kappe, SNCF Ep. V*



VB-308

B9 ex A9, n° 51 87 29-70 306-7,
vert 302 / gris 804 logo encadré
blanc, SNCF Ep.IV-V

B9 ex-A9 Green / Grey White Logo Era IV-V

*B9 ex-A 9, Nr. 51 87 29-70 306-7
grün 302/ grau 804
Logo Weiß umrahmt, SNCF Ep. IV-V*

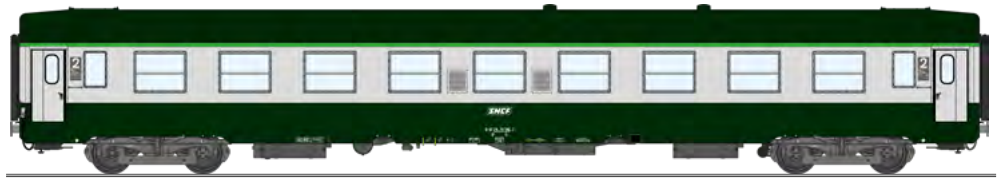

VB-309

B9 ex A9, n° 51 87 29-70 352-7,
vert 302 / gris 804 logo encadré
blanc, SNCF Ep.IV-V

B9 ex-A9 Green / Grey White Logo Era IV-V

*B9 ex A9, Nr. 51 87 29-70 352-7
grün 302/ grau 804, Logo Weiß umrahmt,
SNCF Ep. IV-V*

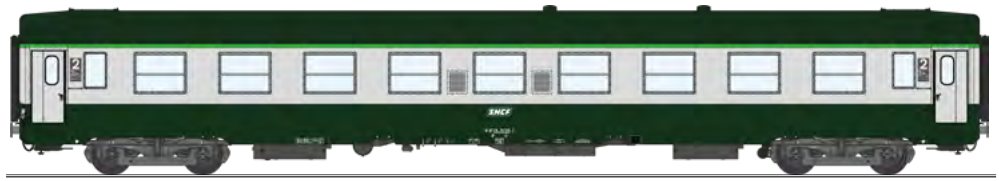



VB-409

Coffret 3 voitures

Ex-PLM, A7 n° 5429,
B8 n° 54472 et 54493,
vert 306, SNCF Ep.III B

*Set of 3 Metallic Cars Ex-PLM,
A7 n°5429, B8 n°54472 and
54493, green 306, SNCF Era III B*

*3er Set Stahlreisezugwagen ehem.
PLM, A7 Nr. 5429, B8 Nr. 54472
und 54493, grün 306, SNCF Ep. III B*



VB-410

A7 n° 5412, vert 306,
SNCF Ep.III B

A7 n° 5412, green 306, SNCF Era III B

A7 Nr. 5412, grün 306, SNCF Ep. III B



VB-411

B8 n° 54476, vert 306,
SNCF Ep.III B

B8 n° 54476, green 306, SNCF Era III B

B8 Nr. 54476, grün 306, SNCF Ep. III B



VB-412

B8 n° 54507, vert 306,
SNCF Ep.III B

B8 n° 54507, green 306, SNCF Era III B

B8 Nr. 54507, grün 306, SNCF Ep. III B

VB-413

A4D n° 5491, feux de fin de convoi, vert 306, SNCF Ep.III B
A4D n°5491, end of convoy lights, green 306, SNCF Era III B

A4D Nr. 5491, Schlusslichter, grün 306, SNCF Ep. III B

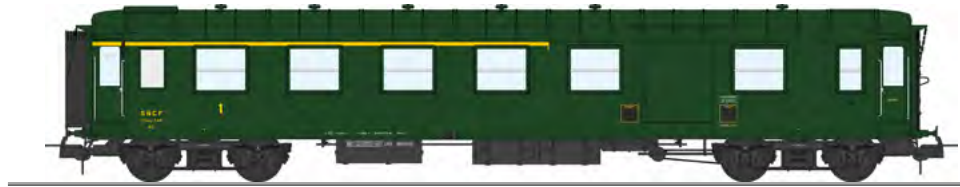

VB-414

A4D n° 5493, feux de fin de convoi, vert 306, SNCF Ep.III B
A4D n°5493, end of convoy lights, green 306, SNCF Era III B

A4D Nr. 5493, Schlusslichter, grün 306, SNCF Ep. III B

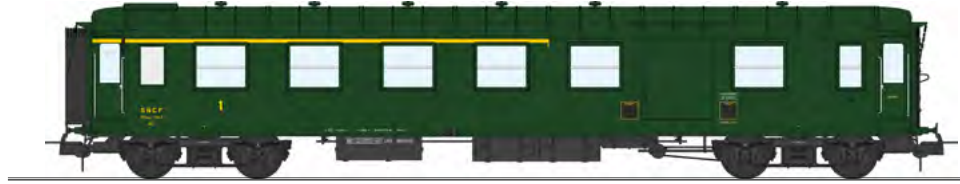

VB-415

B4D n° 54236, feux de fin de convoi, vert 306, SNCF Ep.III B
B4D N°54236, end of convoy lights, green 306, SNCF Era III B

B4D Nr. 54236, Schlusslichter, grün 306, SNCF Ep. III B

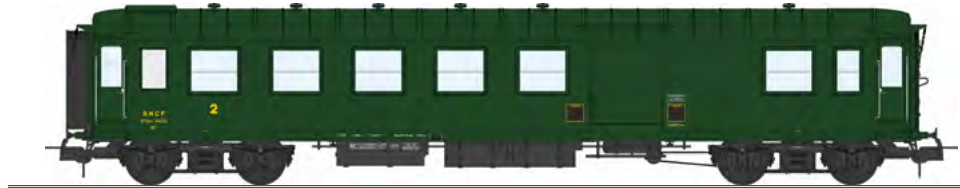

VB-416

B4D n° 54213, feux de fin de convoi, vert 306, SNCF Ep.III B
B4D n°54213, end of convoy lights, green 306, SNCF Era III B

B4D Nr. 54213, Schlusslichter, grün 306, SNCF Ep. III B

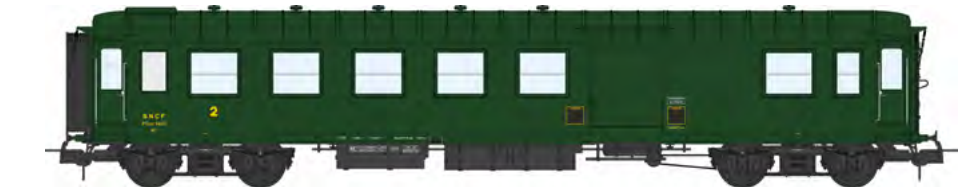

VB-417

A4D n° 51 87 81-40 403-4, feux de fin de convoi, vert 301, SNCF Ep.IV
A4D n° 51 87 81-40 403-4, end of convoy lights, green 301, SNCF Era IV

A4D Nr. 51 87 81-40 403-4, Schlusslichter, grün 301, SNCF Ep. IV

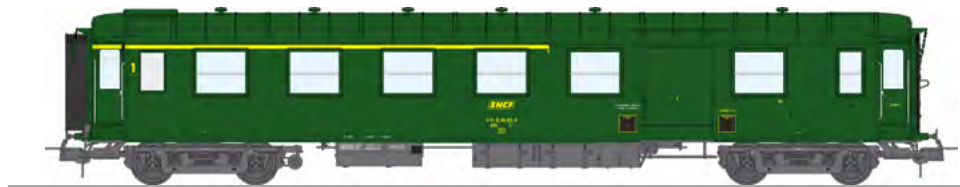

VB-418

A4D n° 51 87 81-40 412-5, feux de fin de convoi, vert 301, SNCF Ep.IV
A4D n° 51 87 81-40 412-5, end of convoy lights, green 301, SNCF Era IV

A4D Nr. 51 87 81-40 412-5, Schlusslichter, grün 301, SNCF Ep. IV

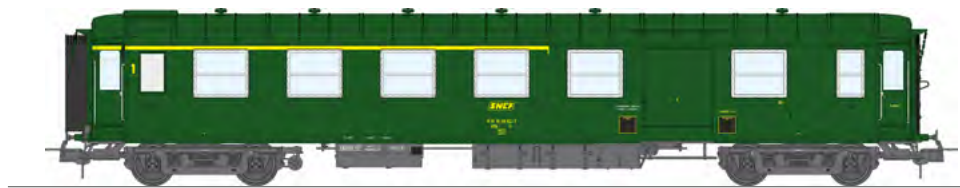

VB-419

B4D n° 51 87 82-40 836-4, feux de fin de convoi, vert 301, SNCF Ep.IV
B4D n° 51 87 82-40 836-4, end of convoy lights, green 301, SNCF Era IV

B4D Nr. 51 87 81-40 836-4, Schlusslichter, grün 301, SNCF Ep. IV

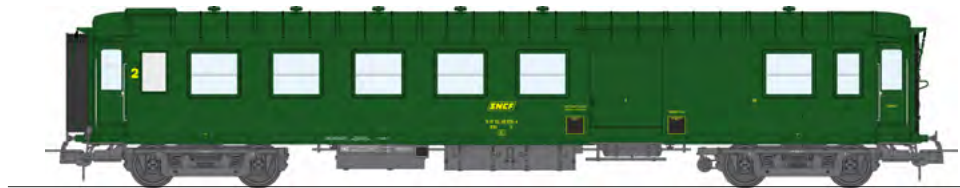

VB-420

B4D n° 51 87 82-40 875-2, feux de fin de convoi, vert 301, SNCF Ep.IV
B4D n° 51 87 82-40 875-2, end of convoy lights, green 301, SNCF Era IV

B4D Nr. 51 87 81-40 875-2, Schlusslichter, grün 301, SNCF Ep. IV

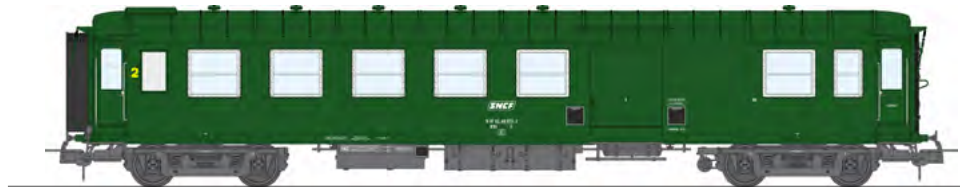



VB-421
Coffret 3 voitures

A7 n° 602, B8 n°5036 et 5033,
PLM Ep.II



Set of 3 Metallic Cars
A7 n° 602, B8 N° 5036 et 5033,
PLM Era II



3er Set Stahlreisezugwagen
A7 Nr. 602, B8 Nr. 5036 und 5033,
PLM Ep. II



VB-422
A7 n° 610, PLM Ep.II

A7 n° 610, PLM Era II

A7 Nr. 610, PLM Ep. II



VB-423
B8 n° 5061, PLM Ep.II

B8 n° 5061, PLM Era II

B8 Nr. 5061, PLM Ep. II



VB-425
A7 n° 607, vert 306,
SNCF Ep.III A

A7 N° 607, green 306, SNCF Era III A

A7 Nr. 607, grün 306, SNCF Ep. III A

VB-424

Coffret 3 voitures

A7 n° 603, C8 n° 11813 et 11802, Vert 306, SNCF Ep.III A

*Set of 3 Metallic Cars Ex-PLM
A7 n°603, C8 n°11813 and 11802,
green 306, SNCF Era III A*

*3er Set Stahlreisezugwagen
ehem. PLM*

*A7 Nr. 603, C8 Nr. 11813 und
11802, grün 306, SNCF Ep. III A*



VB-426

C8 n° 11797, vert 306, SNCF Ep.III A

C8 n° 11797, green 306, SNCF Era III A

C8 Nr. 11797, grün 306, SNCF Ep. III A



VB-427

C8 n° 11832,

vert 306, SNCF Ep.III A

C8 n° 11832, green 306, SNCF Era III A

C8 Nr. 11932, grün 306, SNCF Ep. III A



VB-428

A7 n° 51 87 17-47 045-5, vert 301, SNCF Ep.IV

A7 n° 51 87 17-47 045-5, green 301, SNCF Era IV

A7 Nr. 51 87 17-47 045-5, grün 301, SNCF Ep. IV



VB-429

A7 n° 51 87 17-47 056-2, vert 301, SNCF Ep.IV

A7 n° 51 87 17-47 056-2, green 301, SNCF Era IV

A7 Nr. 51 87 17-47 056-2, grün 301, SNCF Ep. IV





Voitures DEVAO Couchettes U54
 DEVAO Sleeping cars · DEVAO Liegewagen



VB-399
Coffret 3 voitures
 DEV AO Couchettes B9c9 myfi
 n°52063, 52076, 52078
 Vert 306 Ep.III B

*Set of 3 DEV AO Sleeping Cars
 Green 306 B9c9 myfi Era III B*
*3er Set DEV AO Liegewagen
 B9c9 myfi grün 306 Ep. IIIb*



VB-400
 Couchettes Vert
 306 2^{ème} classe B9c9 myfi 32012
 Ep.III B
 Green 306 2nd class B9c9 myfi 32012
 Era III B
 B9c9 myfi 32012 grün 306 Ep. IIIb



VB-401
 Vert 306 2^{ème} classe B9c9
 myfi 32017 Ep.III B
 Green 306 2nd class B9c9 myfi 32017
 Era III B
 B9c9 myfi 32017 grün 306 Ep. IIIb



VB-403
 B9c9 n° 50 87 59-37 153-9
 Bleue/Gris, logo encadré Ep.IV-V
 B9c9nN° 50 87 59-37 153-9 Blue/Grey,
 boxed SNCF logo Era IV-V
 B9c9 Nr. 50 87 59-37 153-9 Blau/grau,
 Logo umrahmt, Ep. IV-V



VB-404
 B9c9 n° 50 87 59-37 160-4
 Bleue/Gris, logo encadré Ep.IV-V
 B9c9 n° 50 87 59-37 160-4 Blue/Grey,
 boxed SNCF logo Era IV-V
 B9c9 Nr. 50 87 59-37 160-4 Blau/grau,
 Logo umrahmt, Ep. IV-V

VB-402

Coffret 3 voitures

B9c9 Bleu/Gris,
n° 51 87 59-30 132-9,
51 87 59-30 126-1,
51 87 59-30 133-7
logo encadré Ep.IV-V



*Set of 3 DEVAO Sleeping Cars B9c9, Blue/
Grey, boxed SNCF logo Era IV-V*

*3er Set DEVAO Liegewagen B9c9 Blau/
grau, Logo umrahmt, Ep. IV-V*

VB-405

Coffret 3 voitures

B9c9 n° 51 87 59-37 140-5,
51 87 59-37 143-9,
51 87 59-37 127-2
Vert 301, logo encadré Ep.IV



*Set of 3 DEVAO Sleeping Cars B9c9, Green
301, boxed SNCF logo Era IV*

*3er Set DEVAO Liegewagen B9c9 grün
301, Logo umrahmt, Ep. IV*

VB-406

B9c9 n° 51 87 59-37 131-4
Vert 301, logo encadré Ep.IV



*B9c9 n° 51 87 59-37 131-4 Green 301,
boxed SNCF logo Era IV
B9c9 Nr. 51 87 59-37 131-4 grün 301,
Logo umrahmt, Ep. IV*

VB-407

B9c9 n° 51 87 59-37 146-2
Vert 302, logo encadré Ep.IV-V
cartouche Corail



*B9c9 n° 51 87 59-37 146-2 Green 302,
boxed SNCF logo Era IV-V
B9c9 Nr. 51 87 59-37 146-2 grün 302,
Logo umrahmt, Ep. IV-V*

VB-408

B9c9 n° 51 87 59-37 147-0
Vert 302, logo encadré Ep.IV-V
cartouche Corail



*B9c9 n° 51 87 59-37 147-0 Green 302,
boxed SNCF logo Era IV-V
B9c9 Nr. 51 87 59-37 147-0 grün 302,
Logo umrahmt, Ep. IV-V*

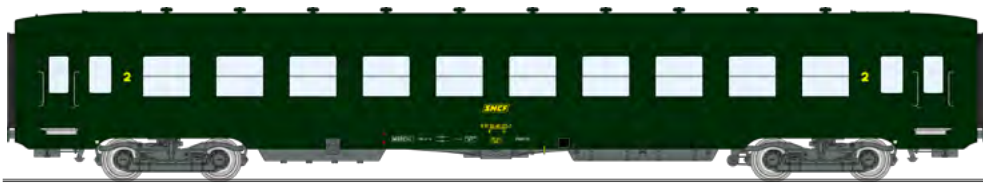

VB-389

Coffret 3 voitures

B10 U52 n° 53127 et 53131,
A8 U53 n° 4127, vert 306,
SNCF Ep.III

*Set of 3 short DEVAO coaches
B10 green 306, SNCF Era III*

*Set aus 3 DEVAO Reisezugwagen kurz,
B10 U52 Nr.53127 und 53131,
A8 U53 Nr.4127, grün 306, SNCF Ep. III*

VB-392

Coffret 3 voitures

B10 U52 n°51 87 20 47 234-7
n° 51 87 20 40 253-7
A8 U53 51 n° 87 18 40 562-5
vert 301, SNCF Ep.IV

*Set of 3 short DEVAO coaches
B10 U52 SNCF 301 green , grey frame,
skirts cut in front of bogies, Boxed yellow
SNCF logo, « Cartouche Corail » class
signage, Ep.V*

*Set aus 3 DEVAO Wagen, Kurz,
B10 U52, grün, Rahmen grau, hochge-
zogene Schürze vor den Drehgestellen,
Corail Schriftzug, Ep.V*

VB-390

B10 U52 n° 53103
vert 306 Ep.III

B10 U52 green 306 Era III

B10 U52 Nr.53103, grün 306 Ep. III

VB-391
A8 U53 n° 2141
vert 306 Ep.III

A8 U53 green 306 Era III

A8 U53 Nr.2141, grün 306 Ep. III



VB-393

B10 U52 n° 50 87 20 40 208-1
vert 301 Ep.IV

B10 U52 green 301 Era IV
B10 U52 Nr. 50 87 20 40 208-1, grün
301, Ep. IV



VB-394

A8 U53 n°50 87 20 40 208-1
vert 301 Ep.IV

A8 U53 green 301 Era IV

A8 U53 Nr. 50 87 20 40 208-1, grün 301,
Ep. IV



VB-395

B8 ex-A8 U53
n°50 87 28 30 047-8
vert 301 Ep.IV

B8 ex-A8 U53 green 301 Era IV

B8 ehem. A8 U53
Nr. 50 87 28 30 047-8, grün 301, Ep. IV



VB-396

Coffret 3 voitures

A7x ex-B8 U53 n°50 87 28 30 015-5
vert 302/gris 804,
2 x B8 ex-A8 n°50 87 28 30 020-2
et n°50 87 18 30 605-6,
vert 302 SNCF Ep.IV-V

Set of 3 U53 DEVAO short cars,
A7x ex B8 green 302/grey 804, and
2 x B8 ex-A8 green 302 SNCF Era IV-V

3er Set DEVAO U53 Reisezugwagen kurz,
A7x ex-A8 grün 302/grau 804,
2 x B8 ex-A8 grün 302, SNCF Ep. IV-V



VB-397

B8 ex-A8 U53
n° 50 87 28 30 026-2
vert 302 Ep.IV-V

B8 ex-A8 U53 green 302 Era IV-V

B8 ehem. A8 U53 Nr. 50 87 28 30 026-2
grün 302 Ep. IV-V



VB-398

B8 ex-A8 U53
n°50 87 28 30 014 -8,
vert 302/gris 804 Ep.IV-V

A8 U53 green 301 Era IV

B8 ehem. A8 U53 Nr. 50 87 28 30 014-8,
grün 302/grau 804, Ep. IV-V





VB-264

Coffret 3 voitures

PLM Ep.II (A3B5yfi 3475
C4Dyi 12332 & C9yfi 12107)
RETIRAGE

Set of 3 OCEM RA Cars PLM Era II
(A3B5yfi 3475 / C4Dyi 12332
C9yfi 12107) RERUN

3er Set OCEM RA Reisezugwagen PLM
Ep. II (A3B5yfi 3475 / C4Dyi 12332
C9yfi 12107) WIEDERAUFLAGE

VB-265

3^{ème} classe C9yfi 12204 PLM
Ep.II - RETIRAGE

C9yfi 12204 - Era II PLM RERUN

3.Klasse C9yfi 12204 PLM Ep. II
WIEDERAUFLAGE

VB-266

1^{ère}/2^{ème} classe A3B5yfi 3483 PLM
Ep.II - RETIRAGE

1 st/2nd class A3B5yfi 3483 PLM Era II
RERUN

1./2.Klasse A3B5yfi 3483 PLM Ep. II
WIEDERAUFLAGE

VB-378

A3B5 Ep.III A

A3B5 Era III A

A3B5 Ep. III A

VB-379

A3B5 ex-Midi toit noir
SNCF Ep.III A

A3B5 ex-South, black roof SNCF Era III A

A3B5 ehem. Midi schwarzes Dach Ep. III A

VB-380
A3B5 toit noir Ep.III B

A3B5 black roof Era III B

A3B5 schwarzes Dach Ep. III B



VB-381
B9 toit noir Ep.III B

B9 black roof Era III B

B9 schwarzes Dach Ep. III B

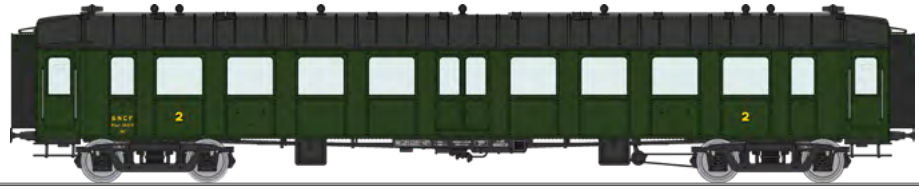

VB-382
Coffret 3 voitures
B4D + 2xB9
toit vert SNCF Ep.III B

Set of 3 OCEM RA Cars

B4D + 2 x B9

Green Roof SNCF Era III B

3er Set OCEM RA Reisezugwagen

B4D + 2 x B9

grünes Dach SNCF Ep. III B



VB-383
B9 toit vert SNCF
Ep.III B

B9 green roof SNCF Era III B

B9 grünes Dach SNCF Ep. III B



VB-384
A3B5 ex-Midi toit noir
SNCF Ep.III B
A3B5 ex-South, black roof SNCF Era III B

*A3B5 ehem. Midi schwarzes Dach
SNCF Ep.III B*



VB-385
A3B5 ex-Midi toit vert
SNCF Ep.III B

A3B5 ex-South, Green Roof SNCF Era III B

*A3B5 ehem. Midi grünes Dach
SNCF Ep. III B*



VB-387
A3B5 - SNCF Ep.IV
A3B5 - SNCF Era IV
A3B5 - SNCF Ep. IV



VB-388
A3B5 ex-Midi Sud-Ouest
SNCF Ep.IV

*A3B5 ex-ex-South, South West - SNCF
Era IV*

A3B5 ehem. Midi Süd-West - SNCF Ep. IV



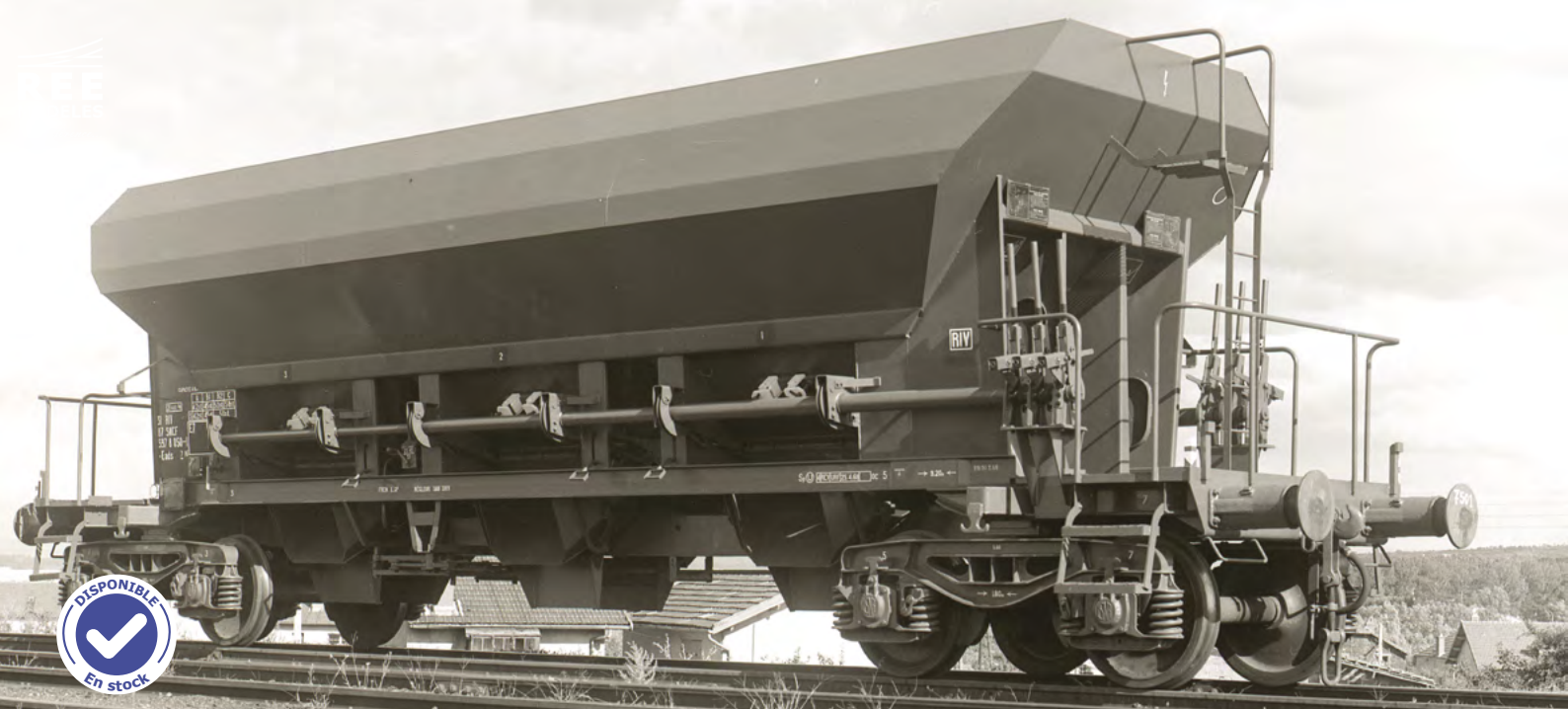

WB-665 F70 Eads SGW
 n° 21 87 057 3 777-1 - Ep.IV

SGW Era IV n° 21 87 057 3 777-1
SGW Ep. IV Nr. 21 87 057 3 777-1



WB-666 F70 Eads SGW
 n° 21 87 057 3 818-3 - Ep.IV

SGW Era IV n° 21 87 057 3 818-3
SGW Ep. IV Nr. 21 87 057 3 818-3



WB-668 F70 Eads SNCF
 n° 31 87 597 8 013-9 - Ep.IV

SNCF Era IV n° 31 87 597 8 013-9
SNCF Ep. IV Nr. 31 87 597 8 013-9



WB-669 F70 Eads SNCF
 n° 31 87 597 8 134-3 - Ep.IV

SNCF Era IV n° 31 87 597 8 134-3
SNCF Ep. IV Nr. 31 87 597 8 134-3



WB-671 F70 Facs SNCF
 n° 33 87 694 1 115-2 - Ep.V

Facs SNCF Era V n° 33 87 694 1 115-2
Facs SNCF Ep.V Nr. 33 87 694 1 115-2

WB-672 F70 Facs SNCF
n° 33 87 694 1 109-5 - Ep.V

Facs SNCF Era V n° 33 87 694 1 109-5

Facs SNCF Ep.V Nr. 33 87 694 1 109-5



WB-667 Coffret de 3 wagons trémie F70 Eads SGW n° 821 87 057 3 856-3 / 21 87 057 4 308-4 / 21 87 057 4 905-7 Ep.IV

Set of 3 hopper F70 Eads SGW Era IV n° 821 87 057 3 856-3 / 21 87 057 4 308-4 & 21 87 057 4 905-7

3er Set Selbstentladewagen F70 Eads SGW Ep.IV Nr. 821 87 057 3 856-3 / 21 87 057 4 308-4 & 21 87 057 4 905-7



WB-670 Coffret de 3 wagons trémie F70 Eads SNCF n° 31 87 597 8 087-3 / 31 87 597 8 168-1 / 31 87 597 8 193-9 Ep.IV

Set of hopper F70 Eads SNCF Era IV n° 31 87 597 8 087-3 / 31 87 597 8 168-1 & 31 87 597 8 193-9

3er Set aus Selbstentladewagen F70 Eads SNCF Ep.IV Nr. 31 87 597 8 087-3 / 31 87 597 8 168-1 & 31 87 597 8 193-9



WB-673 Coffret de 3 wagons trémie F70 Eads SNCF n° 33 87 694 2 014-6 / 33 87 694 2 026-0 & 33 87 694 2 039-3 Ep.V

Set of hopper F70 Facs SNCF Era V n° 33 87 694 2 014-6 / 33 87 694 2 026-0 & 33 87 694 2 039-3

3er Set Selbstentladewagen F70 Facs SNCF Ep.V Nr. 33 87 694 2 014-6 / 33 87 694 2 026-0 & 33 87 694 2 039-3





Wagons trémies F70 Uas ballast

Hopper wagon F70 type · Schotterwagen F70



WB-674 F70 Uas SNCF
n° 80 87 978 0 434-7
Ep.IV

*Uas SNCF n° 80 87 978 0 434-7
Era IV*

Uas SNCF Ep. IV Nr. 80 87 978 0 434-7

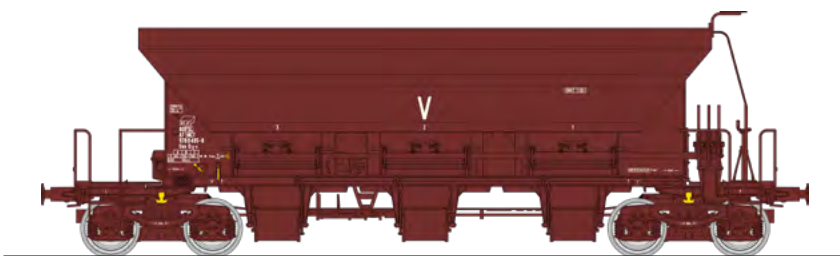

WB-675 F70 Uas SGW
n° 80 87 978 0 495-8
Ep.IV

*Uas SGW n° 80 87 978 0 495-8
Era IV*

Uas SNCF Ep. IV Nr. 80 87 978 0 495-8

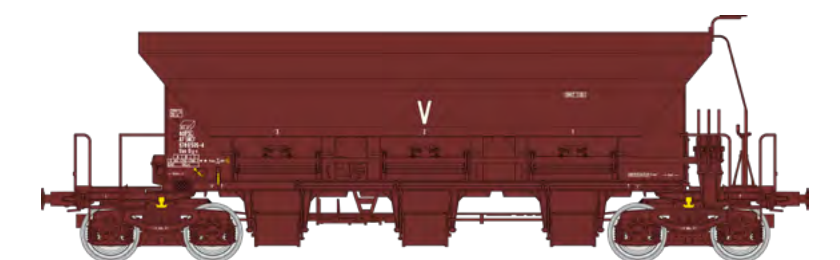

WB-676 F70 Uas SNCF
n° 80 87 978 0 505-4
Ep.IV-V

*Uas SNCF n° 80 87 978 0 505-4
Era IV-V*

Uas SNCF Ep.IV-V Nr. 80 87 978 0 505-4

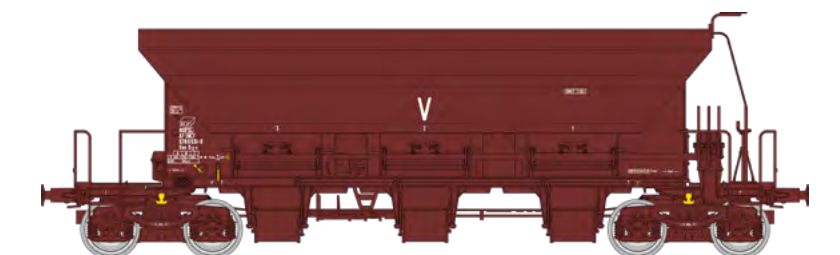

WB-677 F70 Uas SNCF
n° 80 87 978 0 531-0
Ep.IV-V

*Uas SNCF n° 80 87 978 0 531-0
Era IV-V*

Uas SNCF Ep. IV Nr. 80 87 978 0 531-0



WB-680 F70 Uas SNCF
n° 80 87 978 0 651-6
Ep.V

*Uas SNCF n° 80 87 978 0 651-6
Era V*

Uas SNCF Ep. V Nr. 80 87 978 0 651-6

WB-681 F70 Uas SNCF
n° 80 87 978 0 610-2
Ep.V

SNCF n° 80 87 978 0 610-2
Era V

Uas SNCF Ep.V Nr. 80 87 978 0 610-2

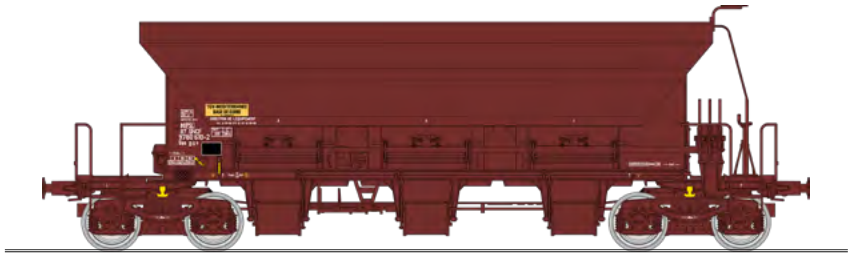

WB-678 Coffret de 3 wagons trémie à ballast F70 Uas SNCF n° 80 87 978 0 618-5 / 80 87 978 0 619-3 / 80 87 978 0 598-3 - Ep.IV
Set of 3 stone hopper F70 Uas SNCF Era IV n° 80 87 978 0 618-5 / 80 87 978 0 619-3 & 80 87 978 0 598-3
3er Set Schotterwagen F70 Uas SNCF Ep. IV Nr. 80 87 978 0 618-5 / 80 87 978 0 619-3 & 80 87 978 0 598-3



WB-679 Coffret de 3 wagons trémie F70 Uas SNCF n° 80 87 978 0 624-3 / 80 87 978 0 634-2 / 80 87 978 0 637-5 Ep.IV-V
Set of 3 stone hopper F70 Uas SNCF Era IV-V n° 80 87 978 0 624-3 / 80 87 978 0 634-2 & 80 87 978 0 637-5
3er Set Schotterwagen F70 Uas SNCF Ep. IV-V Nr. 80 87 978 0 624-3 / 80 87 978 0 634-2 & 80 87 978 0 637-5



WB-682 Coffret de 3 wagons trémie F70 Uas SNCF n° 80 87 978 0 617-7 / 80 87 978 0 621-9 / 80 87 978 0 625-0-3 - Ep.IV-V
Set of 3 stone hopper F70 Uas SNCF Era IV-V n° 80 87 978 0 617-7 / 80 87 978 0 621-9 & 80 87 978 0 625-0
3er Set Schotterwagen F70 Uas SNCF Ep. IV-V Nr. 80 87 978 0 617-7 / 80 87 978 0 621-9 & 80 87 978 0 625-0



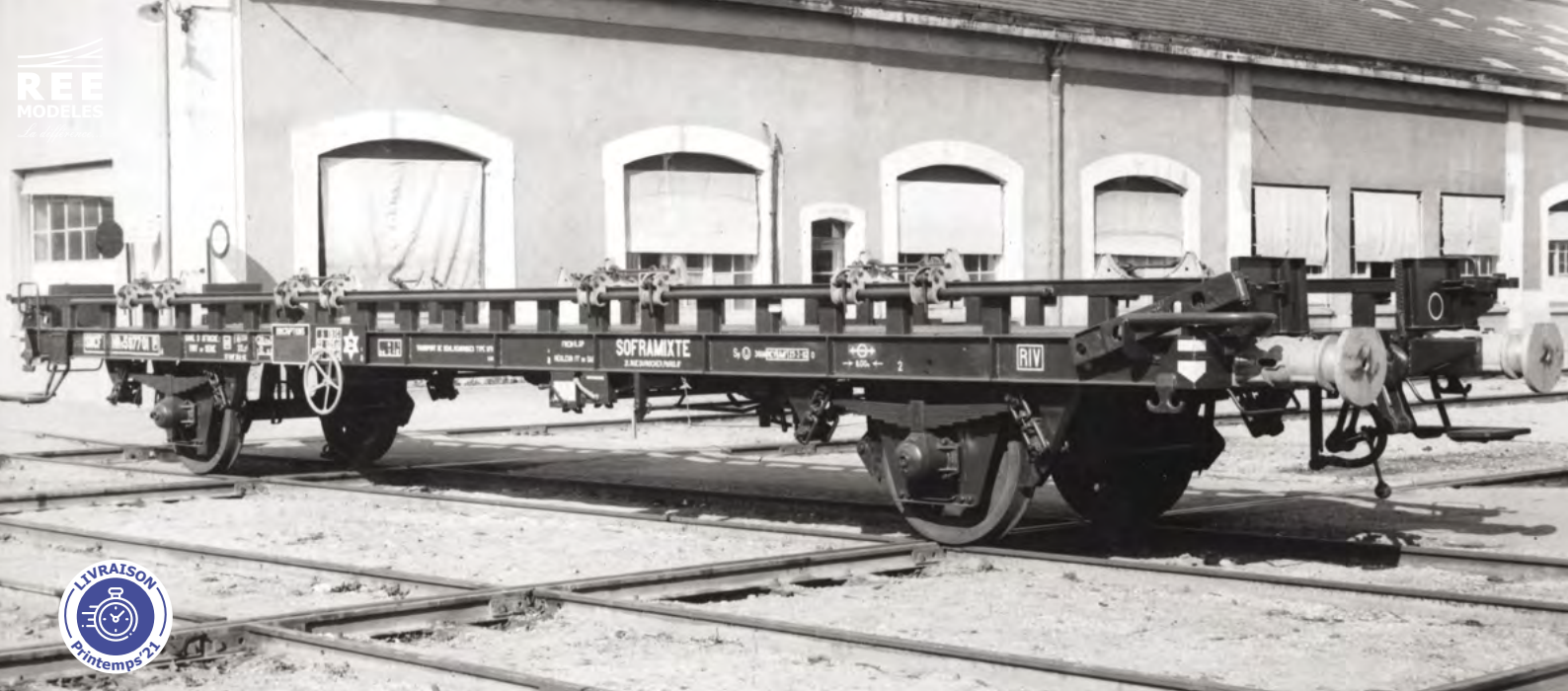

NOUVELLE GRAVURE pour les remorques STEF



WB-634
HR 598203 brun
châssis noir, vide, Ep.III

Era III HR 598203 brown - black frame, without loading

Ep. III HR 598203 braun - Fahrgestell schwarz, unbeladen



WB-635
HR 598106 brun - châssis noir
2 remorques réfrigérantes STEF (avec protections en bois) & STG. Ep. III
Era III HR 598106 brown - black frame 2 trailers STEF (with wooden protection) and STG.

Ep. III HR 598106 braun - Fahrgestell schwarz + 2 Kühlanhänger STEF (mit Holzschutz) und STG



WB-636
HR 598143 brun - châssis noir
2 remorques réfrigérantes STEF avec protections en bois. Ep. III
Era III HR 598143 brown - black frame 2 trailers STEF with wooden protection.

Ep. III HR 598143 braun - Fahrgestell schwarz + 2 Kühlanhänger (STEF mit Holzschutz)

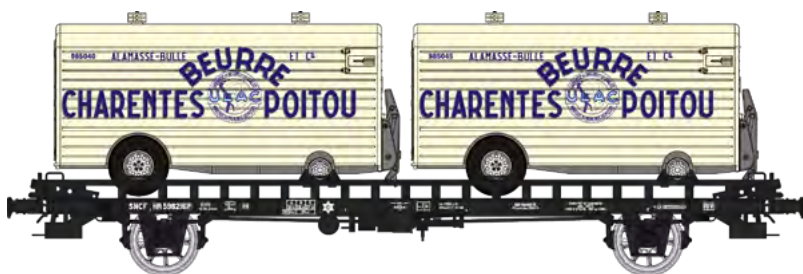

WB-637
HR 598216 noir
2 remorques réfrigérantes Beurre CHARENTES-POITOU. Ep. III
Era III HR 598216 black 2 trailers CHARENTES-POITOU.

Ep. III HR 598216 schwarz+ 2 Kühlanhänger "Beurre CHARENTES-POITOU"

WB-638

Frein à vis HRv 597679 brun - châssis noir
2 remorques fourgons CORDIER, Ep. III

*Era III brake wheel HRv 597679 brown
black frame + 2 trailers CORDIER*

*Ep. III mit Handbremse HRv 597679 braun
+ 2 Kastenanhänger "CORDIER"*



WB-639

Frein à vis HRv 598231 brun - châssis noir
2 remorques fourgons :
PAVESI & BOURGEY-MONTREUIL, Ep. III

*Era III brake wheel HRv 598231 brown black frame
+ 2 trailers PAVESI & BOURGEY-MONTREUIL*

Ep. III mit Handbremse HRv 598231 braun - Fahrgestell schwarz + 2 Kastenanhänger "PAVESI" + "BOURGEY-MONTREUIL"



WB-640

Frein à vis n°21 87 042 1 143-0
rouge UIC, vide, Ep. IV

*Era IV brake wheel 21 87 042 1 143-0
UIC brown - black frame, without loading.*

*Epoche IV mit Handbremse
21 87 042 1 143-0 UIC rot, unbeladen*



WB-641

Frein à vis n°21 87 042 1 172-9 rouge UIC
2 remorques réfrigérantes :
STEF avec protections en bois
& Beurre CHARENTES-POITOU, Ep. IV

*Era IV brake wheel 21 87 042 1 172-9
UIC brown + 2 trailers STEF and CHARENTES-POITOU*

Ep. IV mit Handbremse 21 87 042 1 172-9 UIC rot + 2 Kühlanhänger STEF mit Holzschutz und „Beurre CHARENTES-POITOU“

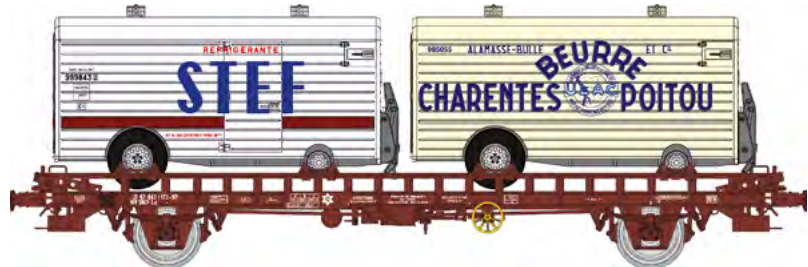

WB-642

Frein à vis n°21 87 042 1 074-7 rouge UIC
2 remorques fourgon :
PAVESI & BOURGEY-MONTREUIL, Ep. IV

*Era IV brake wheel 21 87 042 1 074-7
UIC brown + 2 trailers PAVESI
& BOURGEY-MONTREUIL*

*Ep. IV mit Handbremse 21 87 042 1 074-7 UIC rot
+ 2 Kastenanhänger PAVESI & BOURGEY-MONTREUIL*



WB-643

n°21 87 040 0 143-6 rouge UIC
2 remorques fourgon :
AUTOMOBILES du NORD & PARIS-MILAN Ep. IV

*Era IV 21 87 040 0 143-6 UIC brown
+ 2 trailers AUTOMOBILES du NORD
& PARIS-MILAN*

*Handbremse 21 87 042 1 143-6 UIC rot
+ 2 Kastenanhänger AUTOMOBILES du NORD
& PARIS-MILAN Ep. IV*





WB-644

Noir, roues à rayons n° 597034
Remorque citerne 3 dômes "CECI" - Ep.III

*Black, spoked wheels n°597034
Tank trailer "CECI" Era III*

*Schwarz, Speichenräder, Nr. 597034
+ Dreidomigerkesselanhänger "CECI" Ep. III*



WB-645

Rouge, roues à rayons n° 597062
Remorque citerne "BOURGEY MONTREUIL" - Ep.III

*Brown, spoked wheels n°597062
Tank trailer "BOURGEY MONTREUIL" Era III*

*Rot, Speichenräder, Nr. 597062
+ Kesselanhänger "BOURGEY MONTREUIL" Ep. III*



WB-646

Brun UIC, roues pleines n° 21 87 042 0 257-9
Remorque citerne "BOURGEY MONTREUIL" - Ep.IV

*Brown, plain wheels n° 21 87 042 0 257-9
Tank trailer "BOURGEY MONTREUIL" Era IV*

*UIC braun, Scheibenräder, Nr. 21 87 042 0 257-9
+ Kesselanhänger "BOURGEY MONTREUIL" Ep. IV*



WB-647

Noir, roues pleines n° 597661
Remorque fourgon "BOURGEY MONTREUIL" - Ep.III

*Black, plain wheels n° 597661
Trailer "BOURGEY MONTREUIL" Era III*

*Schwarz, Scheibenräder, Nr. 59766
+ Kastenanhänger "BOURGEY MONTREUIL" Ep. III*



WB-648

Noir, roues pleines n° 597804
Remorque fourgon "TRANSPORTS PAVESI"
Ep.III

*Black, plain wheels n° 597661
Trailer "TRANSPORTS PAVESI" Era III*

*Schwarz, Scheibenräder, Nr. 597804
+ Kastenanhänger "TRANSPORTS PAVESI" Ep. III*

WB-649
Rouge, roues à rayons n° 597829
Remorque fourgon "PARIS-TURIN" - Ep.III

*Red, spoked wheels n°597829
Trailer "PARIS TURIN" Era III*

*Rot, Speichenräder, Nr. 597829
+ Kastenanhänger "PARIS TURIN" Ep. III*



WB-650
Rouge, roues pleines n° 597848
Remorque frigo "STEF" - Ep.III

*Red, plain wheels n°597848
Refrigerator Trailer "STEF" - Era III*

*Rot, Scheibenräder, Nr. 59784
+ Kühlanhänger "STEF" Ep. III*



WB-651
Noir, roues pleines n° 597893
Remorque frigo "STEF" - Ep.III

*Black, plain wheels n° 597893
Refrigerator Trailer "STEF" Era III*

*Schwarz, Scheibenräder, Nr. 597893
+ Kühlanhänger „STEF“ Ep. III*



WB-652
Brun UIC, roues pleines n° 21 87 042 0 048-2
Remorque frigo "STEF" - Ep.IV

*Brown UIC, plain wheels n° 21 87 042 0 048-2
Refrigerator Trailer "STEF" Era IV*

*UIC braun, Scheibenräder, Nr. 21 87 042 0 048-2
+ Kühlanhänger "STEF" Ep. IV*



WB-653
Brun UIC, roues pleines n° 21 87 042 0 076-3
Remorque frigo "GERVAIS" - Ep.IV

*Brown UIC, plain wheels n° 21 87 042 0 076-3
Refrigerator Trailer "GERVAIS" Era IV*

*UIC braun, Scheibenräder, Nr. 21 87 042 0 076-3
+ Kühlanhänger "GERVAIS" Ep. IV*





WB-133 (RETIRAGE)

Brun UIC SNCF n° 30 87 949 7 320-3 freiné, boîte à rouleau, roues pleines Ep.IV "SIOUX"
 UIC Brown SNCF n° 30 87 949 7 320-3 Braked, Plain wheels Era IV "SIOUX" (RERUN)

UIC Braun SNCF Nr. 30 87 949 7 320-3 Gebremst, Rollenlager, Scheibenräder, Epoche IV "Sioux" (WIEDERAUFLAGE)



WB-600 Coffret de 2 plats OCEM 29 Gris PLM NNTouw 57789 et NNTouw 58169 Frein à levier, Roues rayons Ep.II
 Set of 2 OCEM 29 Flat Wagon Grey PLM NNTouw 57789 et NNTouw 58169 Lever brake, Spoked wheels Era II
 2er Set OCEM 29 Niederbordwagen PLM grau NNTouw 57789 und NNTouw 58169 Hebelbremse, Speichenräder, Ep. II



WB-602 Coffret de 2 plats OCEM 29 Rouge Sideros PLM NNTouw 58016 et NNTouw 58998 Frein à levier, Roues rayons Ep.II
 Set of 2 OCEM 29 Flat Wagon Sideros Red PLM NNTouw 58016 et NNTouw 58998 Lever brake, Spoked wheels Era II
 2er Set OCEM 29 Niederbordwagen PLM Sideros Rot NNTouw 58016 und NNTouw 58998 Hebelbremse, Speichenräder, Ep. II



WB-601
 Rouge Sideros PLM NNTouw 57562 Frein à levier, Roues rayons - Ep.II
 Sideros Red PLM NNTouw 57562 Lever brake, Spoked wheels Era II
 Sideros Rot NNTouw 57532 Hebelbremse, Speichenräder, Ep. II



WB-603
 Gris MIDI NNTouw 65722 Frein à levier, Roues rayons - Ep.II
 Grey MIDI NNTouw 65722 Lever brake, Spoked wheels Era II
 MIDI grau NNTouw 65722 Hebelbremse, Speichenräder, Ep. II



WB-604 Coffret de 2 plats OCEM 29 Gris MIDI NNTouw 65624 et NNTouw 65198 Frein à levier, Roues rayons Ep.II
 Grey MIDI NNTouw 65624 et NNTouw 65198 Frein à levier, Spoked wheels Era II
 2er Set OCEM 29 Niederbordwagen MIDI grau NNTouw 65624 und NNTouw 65198 Hebelbremse, Speichenräder, Ep. II

WB-605

Brun SNCF NNTouw 58079 freiné,
Roues rayons Ep.III A
Brown SNCF NNTouw 58079 Braked,
Spoked wheels - Era III A

SNCF braun NNTouw 58079 Gebremst,
Speichenräder, Ep. IIIa



WB-606

Rouge SNCF Jho 103387 freiné,
boite d'essieux à rouleau, roues pleines Ep.III B

Red SNCF Jho 103387 Braked, Plain wheels Era III B

SNCF rot Jho 103387 Gebremst, Rollenlager,
Scheibenräder, Ep. IIIb



WB-607 Coffret de 2 plats OCEM 29 Rouge SNCF Jho 104231 et Jho 104733 Freiné, Boite d'essieux à Rouleau, Roues pleines Ep.III B
Set of 2 OCEM 29 Flat Wagon Red SNCF Jho 104231 et Jho 104733 Braked, Plain wheels Era III B
2er Set OCEM 29 Niederbordwagen SNCF rot Jho 104231 und Jho 104733 Gebremst, Rollenlager, Scheibenräder, Ep. III B

WB-608

Rouge SNCF Nhow 103073 freiné, boîte à rouleau,
roues pleines Ep.III B + 2 cadres "ODOUL"
et "AUX PROFESSIONNELS RÉUNIS"

Red SNCF Nhow 103073 Braked, Plain wheels Era III B
+ 2 containers "ODOUL" and "AUX PROFESSIONNELS RÉUNIS"
Rot Nhow 103073 Gebremst, Rollenlager, Scheibenräder, Ep. IIIb
+ 2 Behälter „ODOUL“ und „AUX PROFESSIONNELS RÉUNIS“



WB-609

Brun SNCF Nhow 103645 freiné, boîte d'essieux
à rouleau, roues pleines Ep.III B

Brown SNCF Nhow 103645 Braked, Plain wheels Era III B

SNCF braun Nhow 103645 Gebremst, Rollenlager,
Scheibenräder, Ep. III B



WB-610

Brun SNCF Jho 104985 freiné, boîte à rouleau,
Roues pleines Ep.III B + cadre "BEDEL & C^{ie}"

Red SNCF Nhow 103073 Braked, Plain wheels Era III B
+ 1 container "BEDEL & C^{ie}"

SNCF braun Jho 104985 Gebremst, Rollenlager,
Scheibenräder, Ep. III B + Behälter "BEDEL & C^{ie}"



WB-611

Brun SNCF Nhow 104509 freiné, boîte à rouleau,
roues pleines Ep.III B + cadre "ALGERIA TRANSPORT"

Brown SNCF Nhow 104509 Braked, Plain wheels Era III B
+ Container "ALGERIA TRANSPORT"

SNCF braun Nhow 104509 Gebremst, Rollenlager,
Scheibenräder, Ep. III + Behälter „ALGERIA TRANSPORT“



WB-612

Brun UIC SNCF n° 21 87 346 0 983-5 freiné,
boite à rouleau, roues pleines Ep.IV

UIC Brown SNCF n° 21 87 346 0 983-5
Braked, Plain wheels Era IV

SNCF UIC braun Nr. 21 87 346 0 983-5
Gebremst, Rollenlager, Scheibenräder, Ep. III





NOUVELLE GRAVURE pour les wagons à guérite



WB-683 Coffret de 2 couverts OCEM 19 KKuw 229005, roues à rayons, volets fermés et KKwf 241572, roues pleines, volets fermés et guérite, MIDI Ep.II.

Set of 2 OCEM 19 Closed Wagon, KKuw 229005, spoked wheels, closed shutters and KKwf 241572, plain wheels, closed shutters, Brakesman Home, MIDI Era II • 2er Set OCEM 19 Gedeckte Güterwagen, Nr. KKuw 229005, Speichenräder, Lüftungsöffnungen zu und Nr. KKwf 241572, Scheibenräder, Lüftungsöffnungen zu und Bremserhaus, MIDI Ep. II



WB-685 Coffret de 2 couverts OCEM 19 KKw 169949, frein à levier, roues à rayon, volets ouverts et KKwf 180718, roues pleines, volets fermés et guérite, PLM Ep.II.

Set of 2 OCEM 19 Closed Wagon, KKw 169949, ever brake, closed shutters, and KKwf 180718, plain wheels, closed shutters, Brakesman Home, PLM Era II • 2er Set OCEM 19 Gedeckte Güterwagen, Nr. KKw 169949, Hebelbremse, Speichenräder, Lüftungsöffnungen offen und Nr. KKwf 180718, Scheibenräder, Lüftungsöffnungen zu und Bremserhaus, PLM Ep. II



WB-687 Coffret de 2 couverts OCEM 19 KKw 320565 et KKw 320294, roues à rayons, volets ouverts, AL Ep.II

Set of 2 OCEM 19 Closed Wagon, N°KKw 320565 and N°KKw 320294, spoked wheels, opened closed, AL Era II
2er Set OCEM 19 Gedeckte Güterwagen, Nr. KKw 320565 und Nr. KKw 320294, Speichenräder, Lüftungsöffnungen offen, AL Ep.II



WB-689 Coffret de 2 couverts OCEM 19 K 251047, roues pleines, volets fermés et KKwwf 180457, roues pleines, volets fermés et guérite, SNCF Sud-Est Ep.III B

K 251047, plain wheels, closed shutters and KKwwf 180457, plain wheels, closed shutters, brakesman home, SNCF South East Era III B
2er Set OCEM 19 Gedeckte Güterwagen, Nr. K 251047, Scheibenräder, Lüftungsöffnungen zu und Nr. KKwwf 180457, Scheibenräder, Lüftungsöffnungen zu und Bremserhaus, SNCF Süd-Ost Ep.III B

WB-684

KKwf 243996, roues pleines, volets fermés et guérite, MIDI Ep.II

N°KKwf 243996, plain wheels, closed shutters, Brakesman Home, MIDI Era II

Nr. KKwf 243996, Scheibenräder, Lüftungsöffnungen zu und Bremserhaus, MIDI Ep. II

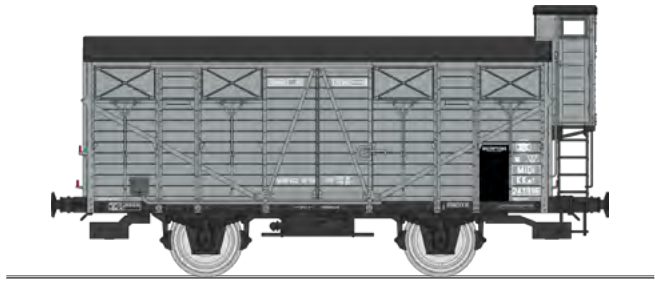

WB-686

KKwf 180732, roues pleines, volets fermés et guérite, PLM Ep.II.

KKwf 180732, plain wheels, closed shutters, Brakesman Home, PLM Era II

Nr. KKwf 180732, Scheibenräder, Lüftungsöffnungen zu und Bremserhaus, PLM Ep. II



WB-688

KK 217248, roues à rayons, volets fermés, EST Ep.II

KK 217248, spoked wheels, closed shutters, EAST Era II

Nr. KK 217248, Speichenräder, Lüftungsöffnungen zu, EST Ep. II



WB-690

K 260062, roues pleines, volets fermés, SNCF Ouest Ep.III B

K 260062, plain wheels, closed shutters, SNCF West Era III B

Nr. K 260062, Scheibenräder, Lüftungsöffnungen zu, SNCF West Ep. IIIB



WB-691

Kf 7281717, roues pleines, volets fermés et guérite, SNCF Sud-Ouest Ep.III B

Kf 7281717, plain wheels, closed shutters, brakesman home, SNCF South West Era III B

Nr. Kf 7281717, Scheibenräder, Lüftungsöffnungen zu und Bremserhaus, SNCF Süd-West Ep. III B



WB-692

Kf 282959, roues pleines, volets fermés et guérite, SNCF Sud-Ouest Ep.III B

Kf 282959, plain wheels, closed shutters, brakesman home, SNCF South West Era III B

Nr. Kf 282959, Scheibenräder, Lüftungsöffnungen zu und Bremserhaus, SNCF Süd-West Ep. III B



WB-693

n° 21 87 105 1 545-5, roues pleines, volets fermés, SNCF Ep.IV

n°21 87 105 1 545-5, plain wheels, closed shutters, SNCF Era IV

Nr. 21 87 105 1 545-5, Scheibenräder, Lüftungsöffnungen zu, SNCF Ep. IV





WB-694 Coffret de 2 couverts PLM 20 t - Gris, Jf 142382 ferrures noires et guérite et JL 151067, avec ferrures noires, PLM Ep.II.
 Set of 2 PLM 20 T Closed Wagon, grey, Jf 142382 with brakesman home and JL 151067, grey PLM Era II
 2er Set PLM 20 t Gedeckte Güterwagen grau, Nr. Jf 142382 mit schwarzen Beschlägen und Bremserhaus und Nr. JL 151067 mit schwarzen Beschlägen, PLM Ep. II



WB-696 Coffret de 2 couverts PLM 20 t - Rouge Sideros, KKwf 185626 avec guérite et KKw 142073, PLM Ep.II.
 Set of 2 PLM 20 T Closed Wagon, Sideros red, KKwf 185626 with brakesman home and KKw 142073, PLM Era II
 2er Set PLM 20 t Gedeckte Güterwagen Sideros Rot, Nr. KKwf 185626 mit Bremserhaus und Nr. KKw 142073, PLM Ep. II



WB-698 Coffret de 2 couverts PLM 20 t - Brun wagon 540, KKwf 144931 avec guérite et KKw 142096 avec renforts de caisse en Z, SNCF Ep.III A.
 Set of 2 PLM 20 T Closed Wagon, Brown, KKwf 144931 with brakesman home et KKw 142096 with Z body reinforcements, SNCF Era III A
 2er Set PLM 20 t Gedeckte Güterwagen Braun, Nr. KKwf 144931 mit Bremserhaus und Nr. KKw 142096, SNCF Ep. III A



WB-701 Coffret de 2 couverts PLM 20 t - brun wagon 540, K 373575 avec renforts de caisse en Z, et Kf391789 avec guérite, SNCF Ep.III B
 Set of 2 PLM 20 T Closed Wagon, brown, K 373575 with Z body reinforcements, et Kf 391789 with brakesman home, SNCF Era III B
 2er Set PLM 20 t Gedeckte Güterwagen Braun, Nr. K 373575 mit Z Verstärkungsstreben und Nr. Kf 391789 mit Bremserhaus, Ep. III B

WB-695

KKwf 148950 ferrures noires et guérite,
PLM Ep.II

KKwf 148950 with brakesman home, PLM Era II

*KKwf 148950 mit schwarzen Beschlägen
und Bremserhaus, PLM Ep. II*

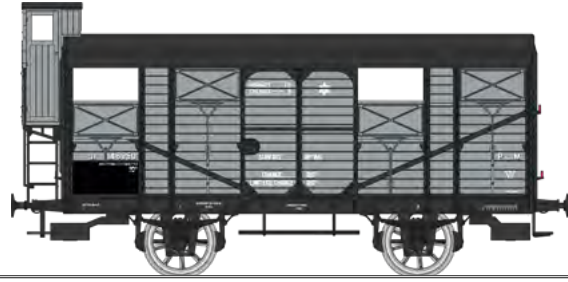

WB-697

Rouge Sideros, KKwf 170556 avec guérite
PLM Ep.II

Sideros red, KKwf 170556 with brakesman home, PLM Era II

Sideros Rot, Nr. KKwf 170556 mit Bremserhaus, PLM Ep. II



WB-699

Brun wagon 540, KKwf 145293 avec guérite,
SNCF Ep.III A.

Brown, KKwf 145293 with brakesman home, SNCF Era III A

Braun, Nr. KKwf 145293 mit Bremserhaus, SNCF Ep. III A



WB-700

KKw 141282 avec renforts de caisse en Z
SNCF Ep.III A

KKw 141282 with Z body reinforcements, SNCF Era III A

*Braun, Nr. KKwf 141282 mit Z Verstärkungsstreben,
SNCF Ep. III A*



WB-702

Brun wagon 540, K 374010 avec renforts de
caisse en Z, SNCF Ep.III B.

*Brown, K 374010 with Z body reinforcements,
SNCF Era III B*

*Braun, Nr. K 374010 mit Z Verstärkungsstreben
SNCF Ep. IIIb*



WB-703

Brun wagon 540, n° Kf 389064 avec guérite,
SNCF Ep.III B

Brown, Kf 389064 with brakesman home, SNCF Era III B

Braun, Nr. 389064 kF mit Bremserhaus, SNCF Ep. III B





WB-654

Bogie Y 23 "SIMOTRA-ESSO", Ep.IV

Bogie Y 23 "SIMOTRA-ESSO", Era IV

Y 23 Drehgestell "SIMOTRA-ESSO", Ep. IV



WB-655

Bogie Y 23 "TOTAL", Ep.IV-V

Bogie Y 23 "TOTAL", Era IV-V

Y 23 Drehgestell "TOTAL", Ep. IV-V



WB-656

Bogie Y 23 "ERMEWA", Ep.V

Bogie Y 23 "ERMEWA", Era V

Y 23 Drehgestell "ERMEWA", Ep. V



WB-657 Coffret de 3 citernes Fauvet-Girel bogie Y 23 "ALGECO-TOTAL", Ep.IV-V

Set of 3 Fauvet-Girel tank wagon, bogie Y 23 "ALGECO-TOTAL", Era IV-V

3er Set Kesselwagen Fauvet-Girel, Y 23 Drehgestell "ALGECO-TOTAL", Ep. IV-V



WB-658 Coffret de 3 citernes Fauvet-Girel bogie Y 23 "ERMEWA", Ep.V

Set of 3 Fauvet-Girel tank wagon, bogie Y 23 "ERMEWA", Era V

3er Set Kesselwagen FAUVET-GIREL, Y 23 Drehgestell "ERMEWA", Ep. V

WB-659
Bogie Y 23 "MOBIL", Ep.III

Bogie Y 23 "MOBIL", Era III
Y 23 Drehgestell "c Ep. III



WB-660
Bogie Y 23 "SHELL", Ep.III

Bogie Y 23 "SHELL", Era III
Y 23 Drehgestell "SHELL", Ep. III



WB-661
Bogie Y 23 "SIMOTRA-TOTAL",
Ep.III

Bogie Y 23 "SIMOTRA-TOTAL", Era III
Y 23 Drehgestell "SIMOTRA-TOTAL", Ep. III



WB-662 Coffret de 3 citernes Fauvet-Girel bogie Y 23 "MOBIL", Ep.III
Set of 3 Fauvet-Girel tank wagon, bogie Y 23 "MOBIL", Era III
3er Set Kesselwagen Fauvet-Girel, Y 23 Drehgestell "MOBIL", Ep. III



WB-663 Coffret de 3 citernes Fauvet-Girel bogie Y 23 "SHELL", Ep.III
Set of 3 Fauvet-Girel tank wagon, bogie Y 23 "SHELL", Era III
3er Set Kesselwagen Fauvet-Girel, Y 23 Drehgestell "SHELL", Ep. III



WB-664 Coffret de 3 citernes Fauvet-Girel bogie Y 23 "TOTAL", Ep.III
Set of 3 Fauvet-Girel tank wagon, bogie Y 23 "TOTAL", Era III
3er Set Kesselwagen Fauvet-Girel, Y 23 Drehgestell "TOTAL", Ep. III

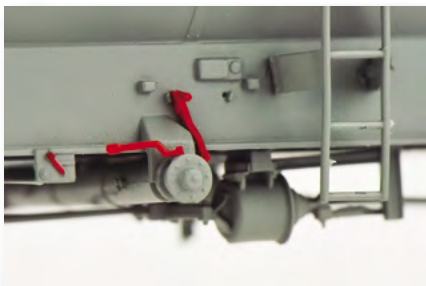



LA COULEUR DES WAGONS DU P.O.

Dans la première moitié du XX^e siècle, les wagons du P.O. sont bruns! Les récents travaux du Cercle Historique du Rails Français pour l'ouvrage «Wagons de France» ont conduit à quelques découvertes sur la couleur des wagons de marchandises. Ces recherches à la source, aujourd'hui facilitées par les moyens informatiques et Internet, bousculent parfois les connaissances fragmentaires parvenues jusqu'à nous et

entérinées par les années. C'est absolument le cas au P.O. Les travaux reposent sur les documents techniques de la compagnie, plusieurs éditions du répertoire de l'association des chemins de fer allemands. Ils sont confortés par les fiches manuscrites du spotter britannique Kenneth Hunter, témoin visuel direct de 30 wagons PO entre 1919 et 1938. Tous ces documents et témoignages, contemporains du matériel, convergent exclusivement sur des nuances de brun plus ou moins fon-

cées, aucun n'évoque le gris. Le brun P.O., appelé brun n° 2 par la compagnie, semble avoir inspiré le brun unifié du cahier de charges n° 36 modifié en 1933. La fusion en 1934 entre le P.O. et le Midi n'a aucune influence sur les parcs respectifs. Il n'est pas totalement exclu que certains wagons puissent avoir été peints en gris et conservés ainsi, c'est même une réelle possibilité pour ceux construits avant 1890.

Notice établie par le CHRF



WB-542

Ranchers longs Ryw 37673
PLM Ep.II

Long ranchers n° Ryw 37673, PLM Era II

Lange Rungen Nr. Ryw 37673, PLM Ep. II

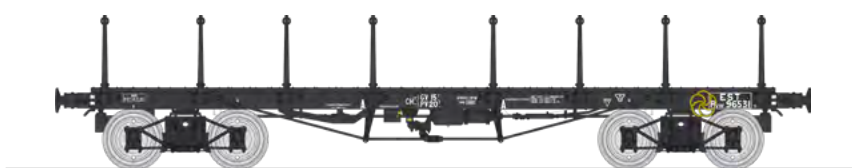

WB-543

Ranchers longs Ryw 96531
EST Ep.II

Long ranchers n° Ryw 96531, EST Era II

Lange Rungen Nr. Ryw 96531, EST Ep. II



WB-544

Ranchers longs et guérite
Rywf 110589, P.O Ep.II

*Long ranchers and Brakesman Home
Rywf 110589, P.O Era II*

*Lange Rungen und Bremserhaus
Nr. Rywf 110589, P.O Ep. II*



WB-545

Ranchers longs et guérite
Rywf 110581 SNCF Ep.III A

*Long ranchers and Brakesman Home
Rywf 110581 SNCF Era III A*

*Lange Rungen und Bremserhaus
Nr. Rywf 110581 SNCF Ep. IIIa*



WB-546

Ranchers longs et guérite
Qrywf 180471 SNCF Ep.III B

*Long ranchers and Brakesman Home
Qrywf 180471 SNCF Era III B*

*Lange Rungen und Bremserhaus
Nr. Qrywf 180471 SNCF Ep. IIIb*



WB-547

Ranchers courts Rzlyw 37829
SNCF Ep.III A

Short ranchers Rzlyw 37829 SNCF Era III A

Kurze Rungen Nr. Rzlyw 37829 SNCF Ep. IIIa



WB-548

Ranchers longs/courts
Ryw 96512, SNCF Ep.III A

*Short and long ranchers Ryw 96512,
SNCF Era III A*

*Kurze und lange Rungen Nr. Ryw 96512,
SNCF Ep. IIIa*



WB-549

Ranchers longs/courts
Qrywv 179491, SNCF Ep.III B

*Short and long ranchers
Qrywv 179491, SNCF Era III B
Kurze und lange Rungen
Nr. Qrywv 179491, SNCF Ep. III B*



WB-550

Ranchers longs 21 87 387 8 693-6
Rkmp5-31 SNCF Ep.IV

*Long ranchers n° 21 87 387 8 693-6
Rkmp5-31 SNCF Era IV
Lange Rungen Nr. 21 87 387 8 693-6
Rkmp5-31 SNCF Ep. IV*



WB-551

Ranchers courts n° 21 87 387 8 895-7
Rkmp5-31 SNCF Ep.IV

*Short ranchers n° 21 87 387 8 895-7
Rkmp5-31 SNCF Era IV
Kurze Rungen Nr. 21 87 387 8 895-7
Rkmp5-31 SNCF Ep. IV*





NOUVELLE GRAVURE

Cette série est consacrée aux wagons type Tams avec couvercle télescopique. Les bogies sont des Y-25 REE Modèles et les wagons sont fabriqués par Sud Express. Les marquages sont conçus et les couleurs validées par REE Modèles.



WBSE-006

Coffret de 2 tombereaux

Tams Ep.V Bogie Y25 (REE)
FRET SNCF n° 31 87 080 7 329-7 & n° 31 87 080 7 342-0 rouge 606 (1992)



Set of 2 Gondola Tams Era.V Bogie Y25
FRET SNCF n°31 87 080 7 329-7 & n°31 87 080 7 342-0 red 606 (1992)

2er Set Hochbordwagen Tams Ep.V
Y25 Drehgestelle (REE)
FRET SNCF Nr. 31 87 080 7 329-7 & Nr. 31 87 080 7 342-0- rot 606 (1992)



WBSE-007

Coffret de 2 tombereaux

Tams Ep.V Bogie Y25 (REE)
FRET SNCF n° 31 87 080 7 345-3 & n° 31 87 080 7 404-6 brun E84 (2000)



Set of 2 Gondola Tams Era.V Bogie Y25
FRET SNCF N°31 87 080 7 345-3 & n°31 87 080 7 404-6 brown E84 (2000)

2er Set Hochbordwagen Tams Ep.V
Y25 Drehgestelle (REE)
FRET SNCF Nr. 31 87 080 7 345-3 & Nr. 31 87 080 7 404-6 braun E84 (2000)



WBSE-008

Tams Ep.V Bogie Y25 (REE)
FRET SNCF n° 31 87 080 7 353-7 rouge 606 (1992)

Tams Era.V Bogie Y25 FRET SNCF
n° 31 87 080 7 353-7 red 606 (1992)
Tams Epoche V Y25 Drehgestelle (REE)
FRET SNCF Nr. 31 87 080 7 353-7 rot 606 (1992)

WBSE-009

Tams Ep.V Bogie Y25 (REE)
FRET SNCF n° 31 87 080 7 333-9 brun E84 (2000)

Tams Era.V Bogie Y25 FRET SNCF
n° 31 87 080 7 333-9 brown E84 (2000)

Tams Ep.V Y25 Drehgestelle (REE)
FRET SNCF Nr.31 87 080 7 333-9
braun E84 (2000)



WBSE-010

Coffret de 2 tombereaux

Tams Ep.V Bogie Y25 (REE)
ERMEWA n° 33 87 0807 314-7 &
n° 33 87 0807 357-6 gris (2015)

Set of 2 Gondola Tams Era.V Bogie Y25
ERMEWA n° 33 87 0807 314-7 &
n° 33 87 0807 357-6 grey (2015)

2er Set Hochbordwagen Tams Ep.V
Y25 Drehgestelle (REE)
ERMEWA Nr. 33 87 0807 314-7
& Nr. 33 87 0807 357-6 grau (2015)

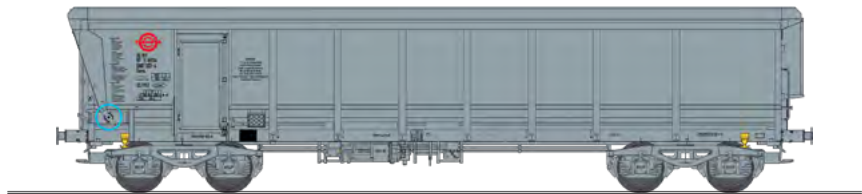

WBSE-011

Tams Ep.V Bogie Y25 (REE)
ERMEWA N° 33 87 080 7 334-5 gris
(2015)

Tams Era.V Bogie Y25 ERMEWA
n°33 87 0807 334-5 grey (2015)

Tams Ep.V Y25 Drehgestelle (REE)
ERMEWA Nr. 33 87 080 7 334-5 grau (2015)





Cette série est consacrée aux wagons type Fas.
Les bogies sont des Y-25 REE Modèles et les wagons sont fabriqués par Sud Express.
Les marquages sont conçus et les couleurs validées par REE Modèles.



WBSE-012

Coffret de 2 tombereaux

Fas Ep.V Bogie Y25 (REE)
n° 31 87 673 6 163-3 sans passerelle &
n° 31 87 673 7 184-8 avec passerelle
(1994)

*Set of 2 Gondola Fas Era.V Bogie Y25
n°31 87 673 6 163-3 without platform
& n°31 87 673 7 184-8 with Brakesman
platform (1994)*

*2er Set Hochbordwagen Fas Ep. V
Y25 Drehgestelle (REE)
Nr. 31 87 673 6 163-3 ohne Bühne &
Nr. 31 87 673 7 184-8 mit Bühne (1994)*



WBSE-013

Fas Ep.V Bogie Y25 (REE)
n° 31 87 673 7 505-4 sans passerelle
rouge 606 (1994)

*Fas Era.V Bogie Y25 N°31 87 673 7 505-
4 without platform, red 606 (1994)
Nr. 31 87 673 7 505-4 ohne Bühne
Rot 606 (1994)*



WBSE-014

Coffret de 2 tombereaux

Fas Ep.V Bogie Y25 (REE)
n° 31 87 673 7 606-0 sans passerelle
(1994) & n°31 87 673 7 198-8 avec
passerelle (1996)

*Set of 2 Gondola Fas Era.V Bogie Y25
n°31 87 673 7 606-0 without platform
(1994) & n°31 87 673 7 198-8 with
Brakesman platform (1996)*

*2er Set Hochbordwagen Fas Ep.V
Y25 Drehgestelle (REE)
Nr. 31 87 673 7 606-0 ohne Bühne
(1994) & Nr. 31 87 673 7 198-8 mit
Bühne (1996)*



WBSE-015

Fas Ep.V Bogie Y25 (REE)
n° 31 87 673 6 356-3 sans passerelle bicolore brun E84 + panneaux R606 (1994)
Fas Era.V Bogie Y25 n°31 87 673 6 356-3 without platform, brown E84 + Red 606 (1994)
Fas Ep.V Y25 Drehgestelle (REE)
Nr. 31 87 673 6 356-3 ohne Bühne zweifarbig braun E84 + rot 606 (1994)



WBSE-016

Coffret de 2 tombereaux

Fas reconstruit Ep.V Bogie Y25 (REE)
n° 31 87 7 650-8 sans passerelle & n° 31 87 673 7 188-9 avec passerelle (2006)

Set of 2 Gondola Fas Era.V Bogie Y25 (reconstructed) Y25 n°31 87 7 650-8 without platform & n°31 87 673 7 188-9 with brakeman platform (2006)



2er Set Hochbordwagen Fas (Umbau) Ep.V Y25 Drehgestelle (REE)
Nr. 31 87 7 650-8 ohne Bühne & Nr. 31 87 673 7 188-9 mit Bühne (2006)

WBSE-017

Fas reconstruit Ep.V Bogie Y25 (REE)
n° 31 87 7 370-3 sans passerelle bicolore brun E84 + panneaux R606 (2004)
Fas Era.V Bogie Y25 (reconstructed) n°31 87 7 370-3 without platform, brown E84 + Red 606 (2004)
Fas (Umbau) Ep.V Y25 Drehgestelle (REE)
Nr. 31 87 7 370-3 ohne Bühne zweifarbig braun E84 + rot 606 (2004)



WBSE-018

Fas reconstruit Ep.V Bogie Y25 (REE)
n° 31 87 6 984-2 avec passerelle bicolore brun E84 + panneaux R606 (2004)
Fas Era.V Bogie Y25 (reconstructed) n°31 87 6 984-2 with brakeman platform, brown E84 + Red 606 (2004)
Fas (Umbau) Ep.V Y25 Drehgestelle (REE)
Nr. 31 87 6 984-2 mit Bühne zweifarbig braun E84 + rot 606 (2004)





CB-130 avec 2 teintes de bleu - Auray (56)
2 blue colors - Auray (56)
In zwei Blautönen - Auray (56)

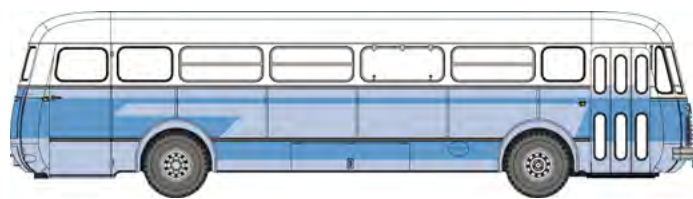

CB-131 Bleu et Blanc - Transport d'Enfants (82)
Blue and white - Transport of Children (82)
Blau und Weiss - Kindertransport (82)



CB-132 Bleu Marine de la CITRAM Bordeaux (33)
Dark blue CITRAM Bordeaux (33)
Marineblau der CITRAM von Bordeaux (33)

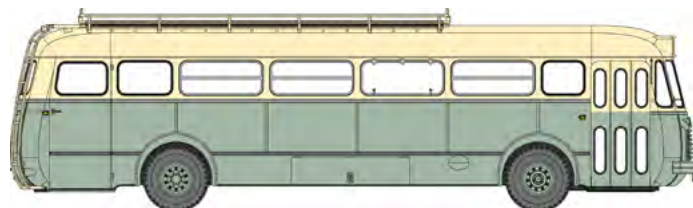

CB-133 Vert et Crème - Vienne (38)
Green and Cream - Vienne (38)
Grün und Creme - Vienne (38)



CB-134 Crème et Marron - CEA Uniroute (75) - Publicité "BIC"
Brown and cream - CEA Uniroute (75) - Publicity "BIC"
Creme und braun - CEA Uniroute (75) - "BIC" Werbung



CB-135 Vert et crème TRANSCAR "LES COURRIERS NORMANDS" (14)
Green and cream - TRANSCAR "LES COURRIERS NORMANDS" (14)
Grün und creme - TRANSCAR "LES COURRIERS NORMANDS" (14)



CB-136 Vert et crème - "VOYAGES TRANSCAR" (75)
Green and cream - "VOYAGES TRANSCAR" (75)
Grün und creme - "VOYAGES TRANSCAR" (75)

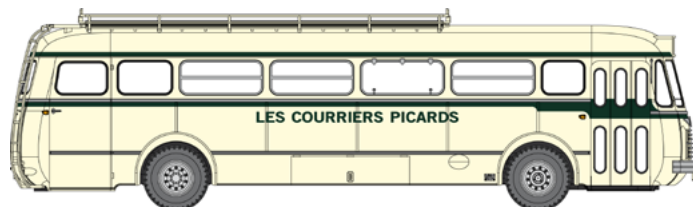

CB-137 Crème - "LES COURRIERS PICARDS" (62)
Cream - "LES COURRIERS PICARDS" (62)
Creme - "LES COURRIERS PICARDS" (62)



CB-138 Bleu et gris - "DROUIN Frères NANTES" (44)
Blue and grey - "DROUIN Frères NANTES" (44)
Blau und grau - "DROUIN Frères NANTES" (44)



CB-139 Bordeaux et gris - "LES TRANSPORTS LENSOIS" (62)
Grey Burgundy color - "LES TRANSPORTS LENSOIS" (62)
Burgunderrot und grau - "LES TRANSPORTS LENSOIS" (62)





www.ree-modeles.com

Suivez-nous sur :    

VOTRE REVENDEUR



RAILS EUROP EXPRESS - 46, route de Paris - 77370 NANGIS

Tél. : +33 (0)1 64 00 31 20

Commercial : info@ree-modeles.com

Service après-vente : sav@ree-modeles.com • Tél. : +33 (0)1 60 58 60 60

Rails Europ Express - S.A.S. au capital de 268.172 € - RCS Annecy 507656916. Tous droits réservés. Copie interdite, même partielle.
Sous réserve de modifications et de disponibilité. Caractéristiques et dimensions sous toutes réserves. Sous réserve d'erreurs de typographie et d'erreurs d'impression,
toute responsabilité est ici exclue. Certaines illustrations montrent des modèles non définitifs dans les détails; la production en série peut diverger des modèles illustrés.
Crédit photos : D. BURAUD, P. SAMBOURG, B. DELAHAYE, D. CABANE, J.-M. STEINER, J.-P. GEAI, J. BUCHMANN, O. TANIQUO, P. JULIEN, Rails d'autrefois, Collection REE
Catalogue imprimé en France • Mai 2021